

January 2007

# The Development of a Dynamic-Interactive-Vehicle Model for Modeling Traffic Beyond the Microscopic Level

Dwayne A. Henclewood

University of Massachusetts Amherst, d\_henclewood@hotmail.com

Follow this and additional works at: <http://scholarworks.umass.edu/theses>

---

Henclewood, Dwayne A., "The Development of a Dynamic-Interactive-Vehicle Model for Modeling Traffic Beyond the Microscopic Level" (2007). *Masters Theses 1911 - February 2014*. 41.  
<http://scholarworks.umass.edu/theses/41>

This thesis is brought to you for free and open access by the Dissertations and Theses at ScholarWorks@UMass Amherst. It has been accepted for inclusion in Masters Theses 1911 - February 2014 by an authorized administrator of ScholarWorks@UMass Amherst. For more information, please contact [scholarworks@library.umass.edu](mailto:scholarworks@library.umass.edu).

**THE DEVELOPMENT OF A DYNAMIC-INTERACTIVE-VEHICLE  
MODEL FOR MODELING TRAFFIC BEYOND THE  
MICROSCOPIC LEVEL**

Thesis Presented

By

DWAYNE ANTHONY HENCLEWOOD

Submitted to the Graduate School of the  
University of Massachusetts Amherst in partial fulfillment  
of the requirements for the degree of

MASTER OF SCIENCE

September 2007

Civil and Environmental Engineering

**THE DEVELOPMENT OF A DYNAMIC-INTERACTIVE-VEHICLE MODEL  
FOR MODELING TRAFFIC BEYOND THE MICROSCOPIC LEVEL**

A Thesis Presented By

DWAYNE ANTHONY HENCLEWOOD

Approved as to style and content by:

---

Daiheng Ni, Chair

---

John Collura, Member

---

Michael Knodler, Member

---

David A. Reckhow, Interim Department Head  
Civil and Environmental Engineering Department

## ACKNOWLEDGEMENTS

I would like to express my deepest gratitude to my advisor, Dr. Daiheng Ni, for all his invaluable contributions towards the completion of this thesis and my Masters degree. He has been a constant guide throughout my graduate studies, providing wisdom and insight into the many tasks at hand while preparing me for future endeavors. Dr. Ni, thank you, for always encouraging me to think outside the box, a vital skill that I will be calling upon as I continue my educational journey.

To Dr. John Collura and Dr. Michael Knodler, I would like to express tremendous appreciation for serving on my thesis defense committee and for their superior tutelage throughout my coursework - making me the transportation engineer that I now am.

I would like to make special mention of the graduate students and staff in the Transportation Engineering Department at the University of Massachusetts Amherst who help me tremendously throughout the pursuit of my Masters degree – Thank you.

To my family, Glenford, Pauline, Marcia, Venecia, Monique and Ryan for their love and constant prayers – thank you.

Thank you - to my beloved friends Jessica, Azizi, Jason and Marsha for all their unceasing love and support especially in the moments when I doubted myself and my abilities. Thanks for keeping me true to my hopes and dreams.

The biggest THANK YOU goes to my God, my Lord and my Savior. Without His tremendous grace and mercy none of this would have been possible. He started me on this journey, saw me through it and now He is preparing for the next step along my life's journey – to Him I owe everything.

## **ABSTRACT**

### **THE DEVELOPMENT OF A DYNAMIC-INTERACTIVE-VEHICLE MODEL FOR MODELING TRAFFIC BEYOND THE MICROSCOPIC LEVEL**

**SEPTEMBER 2007**

**DWAYNE HENCLEWOOD, BA, COLLEGE OF THE HOLY CROSS**

Directed by: Dr. Daiheng Ni

The state-of-the-art traffic simulation packages model traffic on a microscopic level. This includes the use of several sets of models that dictate how traffic moves within a transportation network. These models include car-following, gap acceptance, lane-changing and route choice models. The aim of this thesis is to improve the treatment of vehicle dynamics in traffic simulation and, as a result, special attention was paid to car-following models. These models were highlighted because they are largely responsible for capturing a vehicle's motion and its relevant dynamics in traffic simulation. In order to improve the treatment of vehicle dynamics in traffic simulation, a Dynamic-Interactive-Vehicle (DIV) model was developed. This vehicle model is calibrated with the use of essential vehicle performance specifications that are responsible for the movement of a vehicle in a transportation network. After the calibration process the model is able to accept three inputs from a driver – gas pedal, brake pedal and steering wheel positions. The model then outputs the corresponding longitudinal and latitudinal values which represent the movement of a vehicle along a roadway. The vehicle model will also account for most of the dominant external forces that affect an automobile's

performance along a roadway. This thesis will validate the proposed model by comparing its output from a few performance tests with the performance test results of three passenger cars. The DIV model was validated by comparing the acceleration, braking and steering performance test results of three passenger cars with the output from the DIV model upon performing similar tests. It was found that the DIV model was successful at replicating the two-dimensional vehicle motion.

## TABLE OF CONTENTS

	Page
ACKNOWLEDGEMENTS.....	iii
ABSTRACT.....	iv
TABLE OF CONTENTS.....	vi
LIST OF TABLES.....	x
LIST OF FIGURES.....	xi
CHAPTER	
1 INTRODUCTION.....	1
1.1 The National Problem.....	1
1.1.1 Congestion.....	2
1.1.2 Traffic Safety.....	3
1.1.3 Other Issues.....	4
1.1.4 Solutions.....	4
1.2 Simulation as a Tool.....	6
1.2.1 Simulation in Transportation Engineering.....	7
1.3 Research Problem and Objective.....	9
1.3.1 State of Vehicle Motion in Traffic simulation.....	10
1.3.2 Advancing Vehicle Motion in Traffic simulation.....	11
1.4 Research Approach.....	11
1.4.1 Data and Computing Requirements.....	12
1.4.2 DIV Model's Calibration.....	13
1.5 Anticipated Contributions.....	14

1.5.1	Contribution to Traffic simulation .....	14
1.5.2	Advanced Vehicle Dynamics Representation in Traffic Engineering.....	15
1.5.3	Integrating Advanced Vehicle Dynamics Representation in Traffic Engineering .....	16
1.5.4	Extended Use of Advanced Vehicle Dynamics Representation .....	18
1.5	Thesis Outline.....	19
2	LITERATURE REVIEW .....	21
2.1	Introduction .....	21
2.2	This History of Traffic simulation.....	22
2.2.1	Categories of Traffic Simulators.....	22
2.3	Microscopic Simulation.....	24
2.3.1	Limitations of Microscopic Traffic Simulation .....	25
2.4	The Next Step for Traffic Simulation.....	26
2.4.1	NGSIM Effort to Improve Traffic Simulation.....	27
2.4.2	Nanosopic Traffic Simulation Prototype .....	27
2.4.3	Investment in Traffic Simulation .....	29
2.5	The State of Vehicle Modeling.....	30
2.5.1	Vehicle Modeling in Traffic Simulation.....	30
2.5.2	Car-Following Models.....	31
2.5.3	Advancing Vehicle Dynamics Representation in Traffic Simulation.....	40
2.5.4	Vehicle Modeling in Automotive Engineering.....	42
2.6	Summary.....	44
3	RESEARCH APPROACH .....	46
3.1	Introduction .....	46
3.2	Why Develop the DIV Model .....	46
3.2.1	Acceleration Performance and Vehicle Limitations .....	47
3.2.2	Driver-Environment-Vehicle Interaction.....	47
3.2.3	Lateral Vehicle Movement .....	48
3.2.4	Calibrating Previous Models.....	49



3.3	Description of the DIV Model.....	50
3.4	Implementation of the DIV Model.....	54
3.5	Calibration and Validation of the DIV Model.....	55
3.5.1	Model Calibration.....	55
3.5.2	Model Validation.....	57
3.6	Summary.....	58
4	DEVELOPMENT OF THE DIV.....	59
4.1	The DIV Model.....	59
4.2	Representing Longitudinal Movement.....	61
4.2.1	Equation of Motion of a Two Axel Vehicle.....	61
4.2.2	Force produced by the engine.....	62
4.2.3	Force produce by Braking System.....	67
4.2.4	Force due to Rolling Resistance.....	70
4.2.5	Force due to Aerodynamic Drag.....	71
4.2.6	Force due to Gravity.....	72
4.3	Representing Lateral Motion.....	72
4.4	Summary.....	76
5	VALIDATION OF THE DIV MODEL.....	77
5.1	Measures Used Validate the DIV Model.....	77
5.1.1	Test Vehicles for Validating the DIV Model.....	78
5.2	Validating Acceleration Performance.....	79
5.2.1	The Acceleration Performance Test.....	79
5.2.2	The Test Results.....	80
5.2.3	Evaluation of Test Results.....	83
5.3	Validating the DIV Model's Ability to Decelerate.....	84
5.3.1	The Test.....	85
5.3.2	The Results.....	86
5.3.3	Evaluation of Test Results.....	90

5.4	Validating the DIV Model’s Ability to Represent Lateral Movement.....	92
5.4.1	The Test and Results.....	92
5.4.2	The Reasonableness Test.....	95
5.5	Further Validation of the DIV Model.....	97
5.6.1	Existing Vehicle Acceleration Models vs. DIV Model .....	97
5.7	Summary and Conclusion.....	102
6	SUMMARY, CONCLUSION AND FUTURE DIRECTION .....	104
6.1	SUMMARY .....	104
6.2	CONCLUSION .....	107
6.3	FUTURE DIRECTION.....	109
	APPENDIX: THE DIV MODEL CODE.....	112
	BIBLIOGRAPHY .....	116

## LIST OF TABLES

Table	Page
1 Comparison of Acceleration Performance DIV Model vs. <i>Real Vehicles</i> .....	82
2 Summarized Effectiveness Tests for Braking Performance of Passenger Cars.....	86
3 Braking Performance Results and Analysis.....	89
4 Diameter of Turning Circle - DIV Model vs. <i>Real Vehicles</i> .....	94

## LIST OF FIGURES

Figure	Page
1 The Closed-loop Nanoscopic Simulation System Adapted from [24].....	28
2 Boundaries and Region in Weidmann's Car-Following Model .....	37
3 Forces acting on a two axle vehicle [45] .....	51
4 Schematic Base of the Dynamic-Interactive-Vehicle Model.....	53
5 Forces acting on a two axle vehicle [45] .....	61
6 Key Components of an Engine's Fuel Injector System.....	63
7 Principle behind the engine force and the corresponding driver interaction .....	66
8 The recommended deceleration/pedal force space [46].....	68
9 Principle behind the driver's desire to brake and the accompanying force .....	70
10 Description of the coordinate system and other variables used .....	74
11 Input – Throttle Position vs. Time .....	81
12 Output – Velocity vs. Time.....	81
13 Distance traveled vs. time .....	82
14 Diagonal-Plot Observed vs. DIV Simulated Results; Acceleration Performance .....	84
15 Brake Application vs. Time .....	87
16 Speed vs. Time for Effective Test #2.....	87
17 Distance vs. Time for Effective Test #2 .....	88
18 Diagonal-Plot Observed vs. DIV Simulated Results; Deceleration Performance .....	91
19 Circle scribed by the vehicle's center of gravity in X-Y plane.....	93
20 Diagonal-Plot Observed vs. DIV Simulated Results; Turning Performance.....	94

21	Path traveled: +0.1 and -0.1 steering dialed for 5 and 10 seconds respectively .....	96
22	Acceleration Models & Field Observations vs. DIV Model – Part I [5] .....	99
23	Acceleration Models & Field Observations vs. DIV Model – Part II [5].....	100

# CHAPTER 1

## INTRODUCTION

This chapter provides an overview of the history of the motivation of the topic of this thesis. Afterwards the research problem and objective, as well as the anticipated contributions of the work done in this thesis will be presented. At the end this chapter and outline of the rest of the thesis will also be presented.

### 1.1 The National Problem

Economic development is pivotal to a nation's survival. However, there are a number of adverse effects that are either directly or indirectly related to such development efforts. Several of these adverse effects can be seen throughout a nation's transportation network. One of the more predominant effects plaguing the transportation network is that of congestion. Another significant problem that is also very visible throughout the transportation sector is that of traffic safety. The following sections will serve to highlight the aforementioned issues and strides taken to alleviate some of the negative effects due to these issues. Afterwards, a framework of how this thesis will aid in the pursuit of solutions to these effects will also be presented.

Other noteworthy problems affecting the transportation sector includes its insatiable appetite for energy, the continuous pollution of the atmosphere and its vulnerability to orchestrated attacks. However a framework for the solutions to these problems will not be discussed here as it is out of the scope of this thesis.

### 1.1.1 Congestion

Today's roadways are extremely congested. In 2003, travelers experienced a total of 3.7 billion hours of delay, which includes 54% of travel time being spent in heavy to extreme congestion according to the 2005 Urban Mobility Study conducted by the Texas Transportation Institute. Congest roadways are also responsible for wasting an estimated 2.3 billion gallons per annum. Totaling the cost of time and fuel wasted due to congestion the United States is losing approximately \$70 billion each year. [1]

The dollar value of wasted time and fuel due to congestion is a relatively small portion of its total effects. The effects that congestion has on the environment and on the quality of life experienced are yet to be taken into account. Due to the intangible nature of these effects, it is nearly impossible to determine their dollar value. And without a dollar value or any other similar measure to *prove* the deterioration of the environment and the quality of life, it is difficult to build a case for changing the status quo within the transportation sector.

Although the issue of congestion may be both a direct and an indirect effect of economic development, there are more fundamental causes for the level of congestion experienced on today's roadways. A few of these fundamental reasons include the fact that the demand for mobility is greater than the mobility that is being provided by the roadways. Also another fundamental cause for the amount of congestion along our roadways is that there is the lack of efficient coordination amongst signalized intersections.

Shifting the focus away from infrastructural causes of congestion, drivers also play a significant role in causing delays within the transportation network. Even when

avoidable, drivers often times still make inefficient trip-making decisions. These inefficiencies range from selecting time of travel to the routes taken, especially during trip-chaining. The consequences of these decisions range from more drivers being on the road at once than there needs to be to drivers getting lost, which results in drivers being in the transportation network long than they need to be. These examples of both infrastructure and driver inefficiency are a few of the more primary causes of excess congestion on today's roadways.

### **1.1.2 Traffic Safety**

Traffic safety has also been an area of concern for many individuals, within and outside the transportation profession. From 1994 to 2004 approximately 462, 495 people were killed in 413,169 motor vehicle crashes in the United States. This translates to an average annual fatality rate of approximately 46,250 motor vehicle fatalities per year [2]. Accompanying this statistic are the millions, if not billions of dollars spent as a result of injuries and damaged properties from both non-fatal and fatal crashes on the nation's roadways. A total dollar amount is very difficult to be placed on this *sour* aspect of transportation, but it has been recognized as a severe problem for transportation professionals all around the world.

When looking for reasons behind this large number of crashes, the explanations can be generally categorized in two groups – accidents due to the driver and accidents to the transportation infrastructure. The driver's role in many of these crashes may range from his or her inattentiveness to improper judgment while navigating the vehicle through the transportation network. On the other hand, the network itself may also be at fault for



various reasons ranging from poor signalization of problematic intersections to improper roadway design and insufficient roadway signage.

### **1.1.3 Other Issues**

The previously mentioned issues are some of the more evident and widely recognized challenges facing transportation professionals today. There are many more of equal or greater magnitudes still awaiting solutions as well. Some of these other important issues that consistently confront the profession, as pointed out by the Executive Committee of the Transportation Research Board in their 2006 publication of “Critical Issues in Transportation”, include dealing with emergency situations, energy usages and an aging infrastructure amongst others [3].

### **1.1.4 Solutions**

Despite these numerous challenges, the transportation sector and its many stakeholders have solved or have begun to solve some of these pressing issues. Although the fight against congestion seems like a losing one, as roadways remain clogged on a daily basis especially during rush hours and in the wake of accidents, the transportation profession has taken steps to alleviate its effects. Such steps include instituting HOV and HOT lanes which are an attempt to equalize the *supply* of roadway with the *demand* for mobility. In terms of traffic safety, automobile manufacturers have increased safety features in their units and traffic engineers have been constantly examining ways to enhance facility features to accommodate safer travels.

#### 1.1.4.1 Possible Future Attempts to Alleviate Congestion

There are a number of actions that may be taken to alleviate the effects of congestion, especially as it relates to the aforementioned causes. To address the lack of coordination amongst traffic signals, a *dynamic* transportation network maybe able to move a platoon of vehicles through the network with by alleviating the usual accompanying congestion problems that are associated with uncoordinated traffic signals. A dynamic network would essentially enable the network to adjust its various parameters to their optimal operating state, given current conditions. For example, such a network will take the number of vehicle moving along a corridor and adjust the signal timing plans of the intersections along that corridor to allow the vehicles to traverse the corridor with the least amount of delay as possible.

As for the disparity between supply and demand along the nation's highways, transportation engineers may also employ the use of a dynamic network that can adjust *supply* based on the demand, in real-time with the implementation of real time lane closure mechanisms. Another measure that may keep supply and demand on par is through education, not only educating drivers but also businesses about different steps they can take to help alleviate congestion. Such steps include later, off-peak, start times for particular employees and other such scenarios the will reduce demand during peak hours. In educating the driving public, focus maybe placed on proper trip-planning to avoid confusion and safer driver behavior to decrease the likelihood of being in a crash, which is also a *source* of congestion.

#### **1.1.4.2 Future Attempts to Improve Traffic Safety**

A possible strategy to improve to improve safer travels through the transportation network is to include an in-vehicle driver aid to server as the driver's co-pilot. This mechanism will enable the driver to be more aware and alert of his or her driving environment without overloading him or her with too much information. As for reducing error caused by the transportation facility more care will be needed especially when building new facilities and delineating them. A tool that maybe able to aid in making transportation facilities safer is one that can provide realistic previews of how vehicles will respond within the facility that is planning on being built. When looking to address the issue of safety as it pertains to poor signal timing, a tool integrated with a traffic signal that can *realistically* anticipate and appropriately respond to situations at intersections, including red-light running, may be considered to improve both safety and efficiency with which the signal operates. One such tool that can aid transportation engineers to do just that is traffic simulation packages.

### **1.2 Simulation as a Tool**

Simulation has been a useful tool, not only for analytical purposes but also for sustaining and advancing a number of fields including the transportation and automobile industry. For example, in the field of automotive engineering, simulation has enabled engineers to model a vehicle with all the kinematics and dynamics features accounted for while giving them the opportunity to investigate ways to improve performance, handling and various safety features more effectively. In the realm of transportation engineering,

simulation has revolutionized the manner in which traffic engineers and planners go about their jobs.

### **1.2.1 Simulation in Transportation Engineering**

Traffic simulation has enabled engineers to analyze the current status of transportation networks while providing a better opportunity to make plans to accommodate anticipated demands on the network. Another advantage that traffic simulation has provided to the transportation sector is the ability to accurately and economically foresee the effects of certain adjustments to the transportation network before they are implemented. Such measures range from the evaluation of transit signal priority along a corridor to the addition of a lane to an existing highway or even to the construction of a new highway system. Traffic simulation also provides engineers and planners with unique perspectives when assessing the influences of, say, the construction of a department store or even a particular combination of signal timings. What traffic simulation has done is given the transportation sector the capability to, safely and economically, analyze current network status and, propose and evaluate any changes that may occur within the transportation network.

#### **1.2.1.1 Expanding the Use of Simulation in Transportation Engineering**

Despite all the gains that can be attributed to simulation there is still a lot more that can be done with the use of this tool. The power of simulation, which has been utilized more by the automotive engineering community, facilitates the ability to model in detail, conduct comprehensive analyses and predict actions and reactions, with high-

fidelity. For example, vehicle engineers have simulated trucks and sport-utility-vehicles and have devised means for those vehicles to minimize their risk of rolling over.

If a similar mentality was brought to the world of traffic simulation, one of very detailed modeling, various aforementioned solutions to some of the problems facing the transportation sector would be developed. Take for example, the *tool* that can be incorporated with a traffic signal to improve safety and efficiency through signalized intersections may be developed with the aid of more detailed modeling by traffic simulation. Another solution that may move from being purely a concept to actually being implemented, with the aid of more detailed modeling by traffic simulation, is the driver co-pilot tool. In both these examples, more detail in traffic simulation is required than what is available from today's state-of-the-art traffic simulation packages.

### **1.2.1.2 Advancing Today's Traffic simulation Packages**

Today's traffic simulation packages can model traffic to a *microscopic* level. This level of modeling primarily entails vehicle movement being represented through mathematical proxies such as car-following, lane-changing and gap-acceptance models. Though these models are capable of modeling the essential features and characteristics of traffic, they do not fully account for all the dynamics and the many interactions within a traffic stream that influence traffic's behavior. One of the key dynamic features that today's simulation packages do not fully account for is the acceleration/deceleration capabilities of the vehicles being represented. An example of the interaction that today's simulation packages do not sufficiently represent is the interaction between the driver and the vehicle as they travel within a transportation network. This oversight leaves a

formidable gap in today's simulation as the interaction between the driver and the vehicle is one of the core influences on the vehicle's behavior within the network.

Traffic simulation needs to be armed with additional modeling capabilities in order to be a part of the next level of solutions to alleviate some of today's transportation challenges. These capabilities should facilitate the representation of the key components of a transportation network – the driver, the vehicle and the environment – with greater details. For example, when modeling a motor vehicle, with greater details, the vehicle's engine performance, braking and steering capabilities should be included. These details will not only allow a vehicle's limits to be represented, but also present an opportunity for the vehicle's motion to be more accurately represented based on inputs from the driver and the environment.

### **1.3 Research Problem and Objective**

The problem that this thesis is looking to address is the limited capacity of today's traffic simulation packages that is in part due to the manner in which vehicle movement represented and the lack of sufficient accountability of the interactions amongst the vehicle, the driver and the environment.

In attempting solve this problem this thesis will present the development of a Dynamic-Interactive-Vehicle (DIV) model. This model is aimed at adding more realism to the modeling of vehicle motion in traffic simulation. This will be done through the capturing the essence of the dynamic properties of an automobile. It is also that goal of this model to incite further thinking into the development of future generations of traffic simulation packages.

### 1.3.1 State of Vehicle Motion in Traffic simulation

In today's state-of-the-art traffic simulation packages vehicle motion is dictated by acceleration / car-following, lane changing / gap-acceptance and route choice models along with several other mathematical proxies. For example, a following car will choose to accelerate to get caught up with the preceding car according to the difference in velocity and distance that exist between the two. Though the general structure of this representation of how a vehicle follows another is in fact correct, what it is not completely accounted for is the accelerating capability of the following car. Instead such accelerating capabilities are often times treated via mathematical proxies while being aided by user defined maximum acceleration rates.

Several other instances are treated in a similar fashion. Such instances include a vehicle motion around a horizontal curve, along graded roadways, and in various weather conditions - wind, rain, snow, ice [4]. Although the manner in which developers reflect such events in traffic simulation are quite accurate in comparison to what is observed in the field, it does omit various interactions that are present within these events.

Some of these interactions that are not adequately accounted for in today's traffic simulation packages include those between the driver and the vehicle, the vehicle and the environment, the environment and the driver. And it is these interactions that contribute to driver behavior and subsequently traffic patterns observed in the field. A lack of comprehensive accountability for these interactions is one of the factors currently holding traffic simulation back from continued contribution to the solutions needed to solve some of the challenges facing today's transportation sector.

### **1.3.2 Advancing Vehicle Motion in Traffic simulation**

As mentioned in Section 1.2, traffic simulation is capable of doing more in terms of amount contribution made to the process of finding solutions to the numerous challenges facing transportation engineers today. However, in order for this to happen, traffic simulation has to extend its ability to replicate the reality of traffic more faithfully. To better facilitate this move traffic simulation has to improve the manner in which it accounts for the aforementioned interactions that occur within a transportation network that influences the behavior of traffic. In order to do this, each component of the transportation network - the driver, the vehicle and the environment - must be ably represented to facilitate these interactions.

In light of the manner in which vehicle motion is treated in traffic simulation and its means of inadequately representing several interactions that are important to the way in which traffic behaves within a transportation network; this thesis will be presenting a Dynamic-Interactive-Vehicle (DIV) model to improve these aspects of traffic simulation. This model will be able to present traffic simulation with the ability to better represent vehicle movement by incorporating the essential characteristics of vehicle that contributes to its movement, while facilitating traffic simulation's capability to better account for the driver - vehicle and environment - vehicle interactions.

### **1.4 Research Approach**

The manner in which the DIV model will produce more realistic vehicle motion while accounting all the aforementioned is by first allowing the model to use realistic vehicle specifications, which define its performance ability, and secondly accepts



appropriates user inputs – brake and gas pedal pressure along with dialed steering angles. Once the vehicle specifications are given to the model and the driver inputs are given, the model will output the corresponding acceleration, speed, and position of the vehicle being represented. This manner of representing vehicle motion in traffic simulation is very different from past experiences. Vehicle dynamics was often represented via aggregated approximations in terms of driver inputs, vehicle specifications and vehicle output.

There are many reasons for such representations in the past. These reasons vary from the fact that there was no need to represent vehicle motion with any higher level of fidelity to the fact that there was not enough computing power to process more detailed representations of traffic behavior. Now, with the transportation sector facing more complex problems, there is a need for transportation software packages to be more detailed in their representation of a transportation network; after all the more complex the problem is, the more complex the solution. With computing power increasing rapidly each year and the cost of memory also becoming cheaper yearly, very detailed representations are now more feasible than they were in the earlier stages of traffic simulation.

#### **1.4.1 Data and Computing Requirements**

Despite the increase in computing power and the decrease in the cost of memory; the DIV model, with its high fidelity representation of vehicle dynamics, is not extremely dependent of these advances as one of the key features of the model is that it is *cheap*. Running the DIV model is cheap because it does not require a lot of computational power

nor does require a lot of memory as it effectively captures the essence of an automobile while excluding features that do not directly affect an automobile's performance.

The aspects of the automobile that will be included to account for the vehicle's performance are the engine and the power-train mechanism, the brake system and the steering system. There is one school of thought that modeling an automobile with a high level of fidelity, there will be a need for a lot of information regarding the specifics of the automobile and some of the required data is proprietary but fortunately for the DIV model this is not the case. All the data that the DIV model will need to represent the performance of an automobile are very accessible. All the necessary data are retrievable from the automobile's manufactures websites and other public domain sources. Also, the data required for the model is also easy to decipher and requires no previous automotive knowledge, making the model very user friendly.

#### **1.4.2 DIV Model's Calibration**

Calibrating the DIV model is intended to be a simple and straight forward process. This process will essentially require users to outfit the DIV model with the specifications of the vehicle that he or she is looking to represent with the DIV model. Previous attempts to represent vehicle motion in traffic simulation packages required very data intensive calibration processes. This was needed as the mathematical approximations, which paralleled vehicles to kinetic particles possessing dynamic properties, had to match the reality of vehicle motion. The DIV model minimizes the need for such an extensive calibration process as it mimics the essential processes which determine the dynamic responses of the automobile.

The objective of this thesis is not only to improve the manner in which vehicle motion is represented in traffic simulation but also to represent vehicle motion in traffic simulation more efficiently. The model will effectively employ the key principles that form the foundation of a vehicle's dynamic properties and account for all the aforementioned interactions amongst the driver, vehicle and the environment while reducing the need for tremendous computing power and memory.

## **1.5 Anticipated Contributions**

The benefits of the DIV model being proposed are based in two realms – the realm of traffic simulation and that of professional practice. Although both spheres do overlap each other, this thesis will use them thematically to illustrate as complete a picture as possible of the advantages of formulating the Dynamic-Interactive-Vehicle model.

### **1.5.1 Contribution to Traffic simulation**

When considering the realm of traffic simulation, one of the primary benefits of developing such a model is that it first and foremost extends the work done in [5] as it looks to improve the representation of vehicle dynamics in microscopic simulation. Also this model serves to add to the ongoing movement to improve traffic simulation by placing the emphasis on techniques used to model traffic beyond the microscopic level. The focus of this thesis is to add to the development of beyond-microscopic simulation technology by developing one of its key components – the DIV model (which works with

a driver and an environment model) that would be necessary to make traffic simulation model traffic with higher resolution.

The DIV model will replicate vehicle movement more accurately, bringing a greater sense of realism to the field of traffic simulation. This is not only because the DIV model is able to incorporate the dynamic properties of a vehicle as it traverse within a transportation network, but it also provides a medium for the dynamic properties of the driver and the environment to be included more realistically in traffic simulation. This move begins a development of a simulation technique that will allow all these dynamic properties to interact with each other, within a traffic stream, as they do in the real world. As a result, traffic analysis will be more precise and solutions proposed will be more reliable.

### **1.5.2 Advanced Vehicle Dynamics Representation in Traffic Engineering**

In attempting to highlight possible applications for increasing the level of details in the representation of vehicle dynamics in transportation / traffic engineering, one can begin by evaluating the work done in [6] and [7]. The potential real-world contributions highlighted in these articles primarily centers around improving the Highway Capacity Manual's (HCM) truck performance curves which were develop more the 20 years ago. The major motivation for the improvements in the HCM's performance curves is that the dynamic properties of the entire vehicle fleet have change over the past 20 years. Keeping this fact in mind and understanding the effects of vehicle dynamics on traffic behavior – especially over inclines – the performance curves should be revised.

With greater comprehension of the relationship amongst the dynamic properties of a vehicle, the roadway and the behavior of traffic, transportation engineers involved in highway design may now look to design highways more *efficiently*. What is meant here by more efficient highway design is the designing of highways within the framework of the performance capabilities of the automobile. There are several instances of this thought throughout the interstate system of the United States and overseas with a notable example being Germany's Autobahn. With a greater understanding of the interactions between vehicle dynamics and the highway system (the environment), the tools used by highway engineers, whether it is a simulation package or tabulated calculations, can be better suited to account for these type of interactions and subsequently improve highway designing accordingly. The DIV model can be seen as a key step in this direction as it provides a medium to account of the essential dynamic properties of an automobile and its interaction with roadway.

### **1.5.3 Integrating Advanced Vehicle Dynamics Representation in Traffic Engineering**

Continuing possible professional applications of developing the DIV model, the key mainly lies in the model's ability to facilitate real-time traffic simulation on a different level from what was done in the past. One of the more notable microscopic traffic simulation packages that made use of real-time traffic simulation was HUTSIM, developed by the Helsinki University of Technology. The HUTSIM team initially intended to use this program for the evaluation of traffic signal control. But overtime the program evolved into a general urban traffic and control simulation. For real-time

simulation integration, HUTSIM was connected to real-time traffic data, via detectors, and the information was then used to both evaluate traffic signal control and provide current traffic information to, for example, a traffic control center. This idea was then expanded to more than just signal evaluation and traffic information services, to actually controlling traffic signals, with the aid of HUTSIG. [8]

Various other approaches to this idea were pursued, but in general, the state of real-time traffic simulation did not progress too much beyond this point. This presentation will attempt to move this concept past the point where simulation mainly interacts with the network's environment - i.e. traffic signals, signs - and to the point of possessing the capability to incorporate real-time vehicle movement to aid in the driving process. Due to the scope of this thesis, proper formulation of how this will work will not be discussed here in great details. But the general idea is that once the DIV model is able to successfully replicate a vehicle's movement in a traffic stream, vehicles can be equipped with a unit that will be able to represent itself and its immediate traffic community in real-time. This unit will accomplish this by modeling its own vehicle's movement and the movement of those around it based on drivers' input and the various vehicles' dynamic properties. Once these sets of information have been transmitted amongst the vehicle in a particular area, the drivers in these vehicles will have a lot more information about the surrounding vehicles than he or she would otherwise have.

This information can be used in a myriad of ways to aid the driving process without overloading the driver with information. And again, due to the scope of this thesis, the process of preventing the driver from being over stimulated by such data will not be address here. But one can imagine that upon further development of this model

(and the other involved components of beyond microscopic simulation) the use of this information ranges from allowing drivers to see vehicles beyond his or her human capabilities, i.e. around corners etc., to providing intersections with the ability to respond appropriately to situations like red-light running.

#### **1.5.4 Extended Use of Advanced Vehicle Dynamics Representation**

Other possible uses of advance representation of vehicle dynamics in transportation engineering include automated/cooperative highway designs, more accurate estimates of vehicle pollution, and transportation forensics. The exact methodologies in which advanced vehicle dynamics representation may aid in these areas is not yet know. But possibilities exist as solutions to congestion problems may include the use of a cooperative highway which will possibly look to reduce the headway between vehicles, from say 7 cars to 5 cars. This may be facilitated through a greater understanding of a vehicles' ability to accelerate and decelerate to maintain a more optimal headway.

In terms of increasing the accuracy of estimating vehicular pollution, the DIV model facilitates a more accurate estimation as the model's foundation is built on knowing how much fuel is being used to *drive* the vehicle being represented. By knowing the amount of fuel being consumed by the vehicle and its engine efficiency, the amount of pollutants emitted maybe determined with greater accuracy than the method currently being used by the Environmental Protection Agency (EPA). In essence, the EPA's method of estimating vehicle emission is centered on the average speed at which vehicles are traveling. Although this has been fairly effective means of estimating

vehicle emission in the past, given the *mixed* vehicle fleet and the different levels of engine efficiency of these vehicles a more detailed oriented tool maybe required for more accurate estimates, similar to that of the DIV model.

Transportation forensics / accident reconstruction is a relatively new aspect of traffic engineering. None-the-less it is rapidly emerging as automakers are now including *black-box* technologies to record various vehicle parameters, relating to its motion, especially surrounding the event of an accident. With the availability of such data it will be necessary to have an efficient means of processing this data in an attempt to recreate the crash to analyze what happened and how in could have been prevented. The DIV model is aim to be the beginning of such a tool that may offer the ability to analyze such data and aid in accident recreation, simply and efficiently.

The development of the DIV model is a step for traffic simulation with benefits that span beyond modeling traffic. This model is also geared towards inciting new ideas into the plethora of ongoing discussions and research efforts in traffic safety, Intelligent Transportation Systems (ITS) and Vehicle Infrastructure Integration (VII).

## 1.5 Thesis Outline

The remainder of this thesis will present the development of the Dynamic-Interactive-Vehicle (DIV) model. *Chapter Two* will present the review of relevant literature. This literature review will highlight the history of traffic simulation and the developments that have been taking place to improve traffic simulation packages. A more extensive review of the state-of-the-art traffic simulation is given while paying special attention to the treatment of vehicle dynamics. Also, while looking at vehicle dynamics in transportation



engineering, the manner in which vehicle dynamics is treated in the automobile industry will also be visited. *Chapter 3* will present the research methodology. This section includes a description of the DIV model and its planned development along with steps to implement, and validate the model. *Chapter 4* will present the details of the development of the DIV model and what aspects of the automobile the model will incorporate to efficiently represent its dynamics. *Chapter 5* will present the validation of the model and the corresponding process used to validate the model. *Chapter 6* will provide a summary and future direction of this research.

## CHAPTER 2

### LITERATURE REVIEW

This chapter provides a brief history of the evolution of traffic simulation while focusing on the state-of-the-art, microscopic simulation. Special attention will be placed on how vehicle movement is captured by microscopic traffic simulators and how it maybe improved with the aid of the model that is being proposed in this thesis.

#### 2.1 Introduction

In preparing to develop the Dynamic-Interactive-Vehicle model three aspects of simulation, as it relates to the world of transportation, were reviewed to provided background for this research and well as tools to aid to aid in the development of the model. These areas are the progression of traffic simulation; the representation of vehicle motion in microscopic traffic simulation and a brief overview vehicle modeling that is currently being done in the automotive industry. The history of traffic simulation takes a brief look at the development of traffic simulation from its infantile stage of modeling traffic on a macroscopic level to the state-of-the-art microscopic level. An emphasis will then be placed on microscopic simulation and the current techniques that are used to represent vehicle motion in such simulation packages.

A brief review of the future direction of traffic simulation is also presented in this chapter. Additionally, the role that the proposed DIV model will play in the advancement of traffic simulation is also presented.

## 2.2 This History of Traffic simulation

Traffic simulation had its beginnings in the 1930's with B. D. Greenshields' 1935 paper in which he demonstrated the use of mathematics to aid in the study of highway capacities [9]. The following year, Adams with his 1936 paper extended the application of mathematics to study traffic by using the probability theory to describe traffic flow [10]. In the 1950's with the advances in computing power and programming techniques, traffic simulators were created. In 1955, one of the earliest examples of a traffic simulator was developed by D.L. Gerlough, and presented his dissertation entitled "Simulation of Freeway Traffic on a General-Purpose Discrete Variable Computer"[11]. Afterwards, a large number traffic simulation software packages were produced worldwide for various applications and different levels of resolution when modeling traffic. What is noteworthy here is that the later of these differences is the one that is often used to characterize simulation packages. This is largely due to the fact that it is the resolution that often times goes hand in hand with the time period and the purpose for developing a particular traffic simulator.

### 2.2.1 Categories of Traffic Simulators

There are three categories of traffic simulators that are on today's market. They are macroscopic, mesoscopic and microscopic traffic simulators. A fourth is currently being investigated by researchers and it is aimed at modeling traffic beyond a microscopic or *nanoscopic* level. As for the difference amongst these models, one will notice that their level of resolution is some what synonymous with the prefix of each category. Macroscopic traffic simulation treats traffic as a one dimensional compressible

fluid confined within pipes, which represents disturbances in traffic flow as waves propagating throughout the system. Examples of macroscopic simulators included KRONOS, which was based on the work by Michalopoulos present in [12] in the early 1980s and N-K Waves which is built upon the work done by Newell presented in [13-15] in the early 1990s. [16, 17]

There is often a tendency to lump mesoscopic and microscopic traffic simulators into a single category as they both offer a similar level of resolution when modeling traffic. In both these categories vehicles are treated as particles moving with respect to each other. However the manner in which these *particles* move with respect to each other is the difference between modeling traffic on a mesoscopic scale versus on a microscopic level. Mesoscopic simulation uses cellular automata technology to represent vehicle movement. This technique represents vehicle movement by allowing vehicles to *hop* in and out of cells while obeying a set defined constraints [18]. An example of a mesoscopic traffic simulation package is TRANSIMS, created by Los Alamos National Laboratory [19].

Microscopic traffic simulation, on the other hand, allows vehicles to maneuver within a traffic network via several models such as car-following, lane-changing, gap-acceptance and route choice models. Modeling traffic on a microscopic level represents the state-of-the-art for traffic simulators. Examples of microscopic simulators include AIMSUN, CORSIM, HUTSIM, MITSIM and VISSIM [8, 20-23]. Greater details regarding microscopic simulation and especially its treatment of vehicle movement will be presented later in this thesis.

### 2.3 Microscopic Simulation

Today's microscopic simulation software packages are powerful tools for transportation engineers and planners alike. As previously mentioned modeling traffic on a microscopic scale is the state-of-the-art of traffic simulation. The movement throughout the transportation network work is dictated by mathematical models dictating to each vehicle how to follow another vehicle, change lanes, enter a traffic stream and what streets to take to get from location to another. A large number of these mathematical models have been categorized by the authors of [27]. These categories are Operational, Tactical and Strategic models. The set of *operational* models describes the mathematics that is mainly used to represent vehicle-vehicle interaction throughout the transportation network. This category includes mathematical models that are referred to as acceleration models or car following models. As the name suggests these models attempt to replicate the manner in which one vehicle follows another in a traffic stream.

The set of *tactical* models include a number of mathematical formulations designed to capture a few *special* maneuvers in a transportation network. Such special maneuvers include the merging of a vehicle from one traffic stream to another - captured with the use of gap acceptance models and a vehicle changing from one lane to the next – accounted for by lane-changing models. As for the *strategic* category, this set of models, includes route-choice models. These models are used to essentially represent how a driver chooses his or her path in order to get from Point A to Point B.

### 2.3.1 Limitations of Microscopic Traffic Simulation

All the various mathematical models used in microscopic traffic simulators manage to deliver good estimates as to how vehicles and their drivers travel throughout a transportation network. Given the fact that these models can only provide estimates, the validity as to how well the reality of traffic is represented by microscopic simulators has been a much debated topic. As a result several studies have been done to investigate how well some of the state-of-the-art simulation software packages, such as CORSIM, INTEGRATION, WATSIM, DRACULA and AIMSUN2, modeled traffic's reality. In general the studies found that some fared better than others. One study concluded that most traffic simulators only barely manage to replicate the reality of traffic, even "after considerable modifications to default settings" [25]. While another study highlighted the fact that several of these simulators had *gaps* which prevented them from accurately representing the reality of traffic [26], [4].

#### 2.3.1.1 Microscopic Simulation's Core Limitation

The core of microscopic simulation's limitations is its attempt to model a dynamic closed-loop system as an amalgamation of open-loop systems. In reality navigating a vehicle through a network of roads is a closed-loop operation involving the driver, the vehicle and the environment. These three components form the basis of a traffic network and as navigation occurs within the network information is constantly being sent back and forth amongst these components. In microscopic simulation these three integrated aspects of driving are not represented as such. The only means by which these three components exchange information is through mathematical proxies – general based on

the kinematics of each component and how one component is expected to react to another.

A study of microscopic simulation's treatment of the interactions amongst the key components of the traffic network was present in [4]. The authors provided an inventory of how five categories of influential factors are treated in twelve state-of-the-art traffic simulation packages. These five categories were geometric design, traffic management system, environment and events, vehicle characteristics and traveler characteristics. In supplying this inventory the authors sought to measure how well these traffic simulators account for the impacts of these categories on driver behavior and subsequently traffic behavior. What the authors brought to the forefront is the open-loop system that today's traffic simulation packages are built on, by highlighting the fact that each impact of these influential factors, within traffic simulation, is as a result of a mathematical approximations of expected interactions. These approximations, often in the form of models that do not adequately account for interactions among the driver, the vehicle and the environment that often occur and influence driver and traffic behavior within a *real* transportation network.

#### **2.4 The Next Step for Traffic Simulation**

Traffic simulation has moved from considering traffic as a large number of vehicles moving together as one fluid body to where it is now, capable of modeling traffic based a single car's interaction with another. In recent years, there have been numerous efforts to increase the level of resolution with which traffic is being modeled while increasing the realism with which traffic simulation models traffic's reality.

Currently, the Next Generation Simulation (NGSIM) Community is leading an effort to improve microscopic traffic simulation; while the author of [24] is proposing a prototype for nanoscopic traffic simulation.

#### **2.4.1 NGSIM Effort to Improve Traffic Simulation**

The NGSIM community is looking to make microscopic simulator model traffic more realistically by developing a core of open behavioral algorithms with supporting documentation and validation data sets that describe the interactions of multi-modal travelers, vehicles and highway systems, and interactions presented to them from traffic control devices, delineation, congestion and other features of the environment [25]. This work represents a step towards the tremendous advancements that is needed in the field of traffic simulation. Taking this step brings more accurate approximations to the manner in which the movement of traffic is represented is a transportation network. The core of behavioral algorithms, which are being proposed by the NGSIM community, will represent the various interactions that occur amongst the driver, the vehicle and the environment, giving traffic simulation the ability to model traffic more realistically.

#### **2.4.2 Nanoscopic Traffic Simulation Prototype**

The nanoscopic traffic simulation prototype that has been propose is aimed at modeling traffic not with use of mathematical models approximating the interactions amongst the component of a traffic network but by using models to represent the components themselves and allowing them to interact as they would in reality. This



prototype consists of a vehicle model, a driver model and an environment model which are integrated into a driver-vehicle-environment closed-loop interactive system.

In this closed-loop interactive system, which is meant to mimic the driving reality more closely, the driver model is capable of receiving and processing stimuli from the environment while have the capability to send information to the vehicle model. The vehicle model will in turn execute these driving instructions, while interacting with the environment via the *environment* model, and respond accordingly. This vehicle model is also capable of sending information, regarding its movement and any other relevant information back to the driver model for the driver to respond accordingly. Greater details of such this framework is presented in [24] where the driver model is referred to as an Autonomous-Intelligent-Driver (AID) and the vehicle model referred to as the Dynamic-Interactive-Vehicle (DIV) model - the subject of this thesis. This closed-loop framework, illustrated in **Figure 1**, maps the driving reality much more closely than the current level with which microscopic simulation models the driving process.

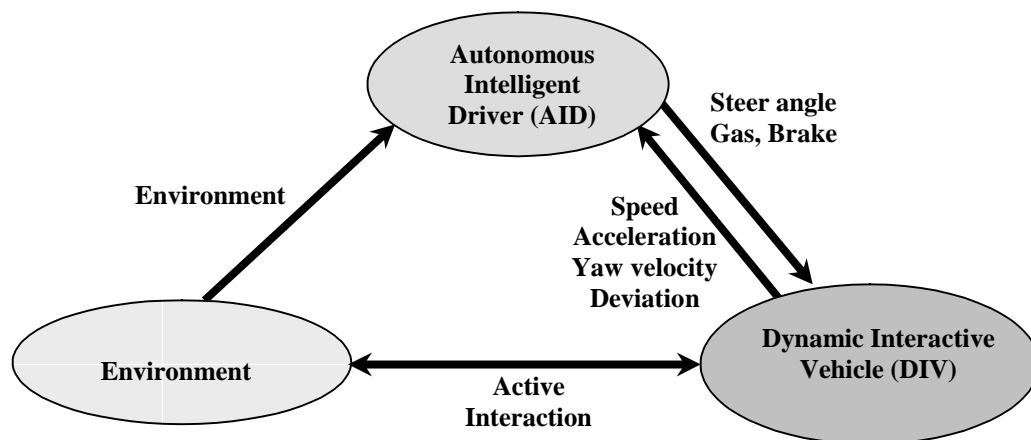

**Figure 1 - The Closed-loop Nanoscopic Simulation System Adapted from [24]**

### 2.4.3 Investment in Traffic Simulation

Given the possible benefits that lay within modeling traffic with greater details it is encouraged that the traffic engineering community increase its investment in beyond-microscopic traffic simulation. Beyond-microscopic simulation will allow traffic simulators to match the reality of traffic more closely and accurately while continuing the current efforts by the NGSIM community and the aforementioned nanoscopic prototype. To further improve the state of traffic simulation, the representation of traffic requires a move from a system that is built on the approximations of the various interactions amongst the components of the traffic network. To a system that models the components of the traffic network separately and allow them to interact with each other - just as it occurs in reality. In order for this to take place, each component, the driver, the vehicle, and the environment, has to be made dynamic with the ability to accept, respond to and transmit data amongst themselves.

In light of the aforementioned sections, the status of vehicle modeling in traffic simulation, and its importance to the development of beyond-microscopic simulator this thesis is proposing a dynamic vehicle model to begin the retooling process of traffic simulation. Subsequently the following section will highlight state of vehicle modeling in traffic simulation and provide a brief overview of the status of vehicle modeling in the automotive industry.

## **2.5 The State of Vehicle Modeling**

In light of the scope of this research, the following section will discuss the modeling of vehicle dynamics in traffic simulation while briefly commenting on the representation of vehicle dynamics in the automotive engineering. From this section one will realize that the major difference between these two fields when representing vehicle dynamics and their effect is the amount of details they chose to incorporate in their modeling efforts. automotive engineering employs very detailed representations of all the various components of the automobile and the relevant dynamic properties while transportation engineering on the other hand employs a blanket treatment of these dynamic properties with various mathematical to capture the essence of vehicle motion in a traffic network.

### **2.5.1 Vehicle Modeling in Traffic Simulation**

Representing vehicles in traffic simulation is largely motivated by desire analyze the manner in which a large number of vehicles move throughout a transportation network. As a result detailed modeling of the dynamic characteristics of a vehicle is not as important as the essence of the manner in which vehicles travel on the roadway. As a result traffic simulation treat vehicle dynamics and the corresponding motion with mathematical approximations that capture the vehicle-vehicle interactions that takes place in a traffic stream.

Microscopic simulation considers the vehicle as a part of the larger driver-vehicle unit, which is treated as a floating single kinetic particle. The movements of these particles are governed by mathematical models such as car-following, gap-acceptance

and lane-changing models. These models, along with a few user specified vehicle characteristics such as desired and maximum/minimum speeds and acceleration, traffic simulation is now able to represent vehicle motion.

The focus of this thesis is the development of a vehicle model to improve the realism with which vehicle motion is represented in traffic simulation. And as a result the following section provide details involving car-following models as this set is models is primarily responsible for capturing vehicle dynamics and representing vehicle motion in traffic simulation.

### **2.5.2 Car-Following Models**

The development of car-following models or acceleration models, as they are sometimes called, began in the early 1950's. Their aim is to accurately describe how one vehicle follows another in a traffic stream. In doing so, these models often define the acceleration or position of the following car by considering the speeds of the individual vehicles and the spacing between them. Over the years there have been several different methodologies that have been used to determine the following vehicle's acceleration, as it follows the leading car. As a result the following section will provide an overview of only a few of these models and their methodologies that have been implemented in some of today's microscopic traffic simulators and that are more relevant to the focus of this thesis.

### 2.5.2.1 L. A. Pipes Model

L. A. Pipes, in his 1953 paper, sought to analyze the dynamics of a line of traffic using mathematical formulation. This work utilized the idea that the movement of a vehicle in line of traffic is partially dictated by a law of separation. This law suggests a minimum following distance, based *loosely* on the California Vehicle Code that drivers should maintain between themselves and the leading car. According to the California Vehicle Code this distance is defined as a vehicle length ( $\approx 15$  feet) for every 10 mph the following vehicle is traveling. Given that this minimum distance is maintained; Pipes formulated an equation that describes the dynamics a line of traffic. See Equation 2.1. [26].

$$\begin{aligned} (Tp+1)V_{k+1} &= V_k + Tp v_{k+1}(0) \\ \text{for } k &= 1, 2, 3, 4, \dots (n-1). \end{aligned} \quad (2-1)$$

The above equation defines the velocity of the following vehicle,  $V_{k+1}$ , as a function of the velocity of the leading vehicle,  $V_k$ , and minimum following distance  $Tpv_{k+1}(0)$ . This equation represents the typical format of a car-following model that uses the fact that a desired measure, in this case the minimum following distance, dictates how the one vehicle follows another.

### 2.5.2.2 Gazis – Herman – Rothery (GHR) Model

The GHR model, other wise known as the Fifth Generation General Motors (GM-V) model is a comprehensive representation of one of the most researched

methodologies used to describe car-following. The main principle behind this model, and that of several other models before and after, is that the driver of the following car responds proportionally to a particular stimulus.

$$response = sensitivity \bullet stimulus \quad (2-2)$$

In this car-following formulation, the *response* refers to the acceleration of the following car as this quantity is directly controlled by the driver through the use of the gas and brake pedals. The *stimulus* that the driver of the following car responds to is the relative speed of his or her car to the leading car. As of the *sensitivity*, it is essentially meant to capture all other factors in order for a formulation of this nature to match the reality it is attempting to represent. And as a result this sensitivity factor has been the subject of many research efforts.

GHR model had its beginnings in a family of follow-the-leader models that first suggested the sensitivity factor was a constant [27]. This resulted in equation 2-2 being written as:

$$\ddot{x}_{n+1}(t+T) = \lambda[\dot{x}_n(t) - \dot{x}_{n+1}(t)] \quad (2-3)$$

where  $x_n$  is the position of the  $n^{\text{th}}$  car,  $T$  is the time lag of the driver's response to the stimulus and  $\lambda$  the sensitivity, which is represented as  $\lambda/M$  in [27], and the dot  $x_n$ s represent the time derivative of the vehicles' position. The sensitivity factor was then revised and it was proposed in [28] that it should be inversely proportional to the distance between the following and lead car. This sensitivity factor underwent several other iterations, after which a general expression was formulated based on few of these iterations – equation 2-4.

$$\lambda = a \dot{x}_{n+1}^m(t+T) / [x_n(t) - x_{n+1}(t)]^l \quad (2-4)$$

where  $a$ ,  $m$  and  $l$  are all constants used to allow experimental data to match observation as close as possible and capture car-following under variety of traffic conditions.

Combining equation 2-3 and 2-4 the GM-V car-following is as follows:

$$\ddot{x}_{n+1}(t+T) = \frac{a \dot{x}_{n+1}^m(t+T) [\dot{x}_n(t) - \dot{x}_{n+1}(t)]}{[x_n(t) - x_{n+1}(t)]^l} \quad (2-5)$$

The GM-V model has been one of the more successful and versatile car-following models and as a result it has been the platform of many other research efforts and has been, partially and fully, incorporated in a number of microscopic simulators. Such simulators include MITSIM and Transmodeler [29]. [30]

### 2.5.2.3 Gipps Behavioral Car-Following Model

Gipps car-following model was designed with three primary goals in mind: (1) to mimic the behavior of real, similar to goals of previous model, (2) to use parameters that correspond to obvious vehicle and driver characteristics – eliminating the need for elaborate calibration processes, and (3) to be well behaved when the time interval between successive recalculations of speed and position is equal to the reaction time. To accomplish these goals Gipps used a similar mind set as Pipes as his model was also built of the fact that a set distance should be maintained between the following and lead vehicles. However Gipps' behavioral model was far more complex than that.

Gipps car-following model was derived by setting limits on the performances of the driver and the vehicle. Given these limitations, the model should be able to output

safe speeds at which the following vehicle should travel. Additionally, this safe speed that the driver of the following vehicle is traveling at is assumed to be a speed from which he or she can bring the vehicle to rest in the event that the lead car should stop suddenly.

After considering the limitations of the driver and the vehicle and a few other constraining factors, Gipps behavioral model is able to output a set containing two different speeds. The minimum of these two speeds is the speed of the following vehicle under one of two different traffic flow conditions. If

$$v_n(t + \tau) = b_n \tau + \sqrt{b_n^2 \tau^2 - b_n (2[x_{n-1}(t) - c_{n-1} - x_n(t)] - v_n(t) * (\tau) - \left(\frac{v_{n-1}^2(t)}{b_{n-1}}\right)} \quad (2-6)$$

is the limiting condition for almost all of the (following) vehicles then congest flow exists and the vehicle is moving as fast as the volume of vehicles permits. However if

$$v_n(t + \tau) = v_n \tau + 2.5 a_n \tau \left( \frac{1 - v_n(t)}{V_n} \right) \left( \frac{0.025 + v_n(t)}{V_n} \right)^{1/2} \quad (2-7)$$

is the limiting condition the of the speeds of following vehicles then free flow traffic conditions exists. Where:

- $a_n$  = maximum acceleration which the driver of vehicle  $n$  wishes to undertake
- $b_n$  = most severe braking that the driver of vehicle  $n$  wishes to undertake
- $s_n$  = length of vehicle  $n$  plus the distance minimum between vehicle
- $V_n$  = speed at which driver of vehicle  $n$  wishes to travel
- $x_n(t)$  = location of the front of vehicle  $n$  at time  $t$
- $v_n(t)$  = speed of vehicle at time  $t$
- $\tau$  = apparent reaction time



Gipps behavioral car-following model and other similar models, such as those presented in [26] and [31], that essentially determine the speed and/or acceleration of the following vehicle by proposing that the following vehicle maintain a safe measure, for example distance, are particular are partially or fully implemented in simulators such as AIMSUN2, CORSIM and INTEGRATION [29]. [32]

#### **2.5.2.4 Weidmann Psycho-Physical Car-Following Model**

As time progressed, the nature of car-following models became more complex as researchers looked for ways to allow car-following models to more realistically replicate the manner in which one vehicle follows another. Not only did the mathematics involved become more complicated but also the concepts used to replicate car-following. Weidmann's 1974 car-following model was one of the more intricate models of that time and now. This car-following model utilized a number of boundaries and regimes to describe vehicle motion within the boundaries. **Figure 2** illustrates the various boundaries and regions that are considered in the Weidmann's car-following model at hand.

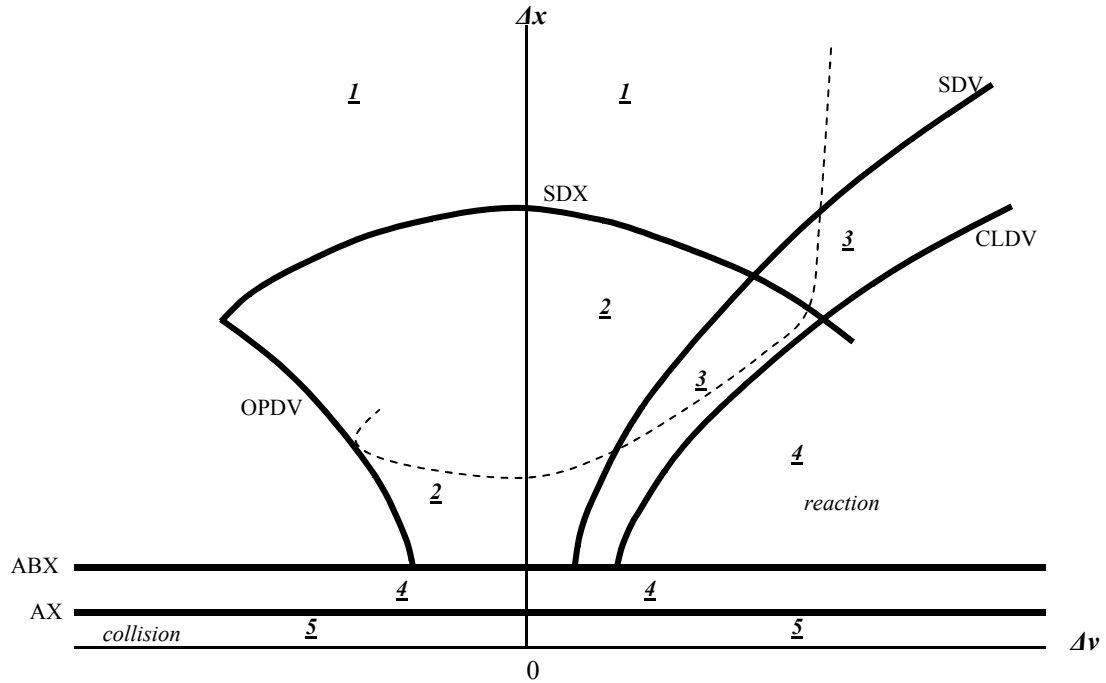

**Figure 2 - Boundaries and Region in Weidmann's Car-Following Model**

*Boundary Definitions:*

*SDV* Perception threshold of speed difference at long distance. Above *SDV* no influence – outside driver perception zone

*CLDV* Perception threshold for recognizing small speed difference at short decreasing distances

*AX* Bumper to bumper distance between two cars under stopped condition

*ABX* Comfortable distance between two cars at stopped condition or minimum following distance

*SDX* Perception threshold of gaining distance in following process

*OPDV* Perception threshold for recognizing small speed difference at short but increasing distance

*Region Definitions:*

- 1- Leading car has no influence on the following car. Free flow traffic condition
- 2- Car following zone
- 3- Following car closing in on the leading car
- 4- Emergency zone, driver of following car prepared for emergency braking
- 5- Collision

The summarizing above diagram and definitions it is the perception of the following vehicle's driver that determines the car-following *mode* just as it is in reality. This model represents the foundation of VISSIM's car-following methodology along with the use of Pipes model – under steady state conditions. [29, 33-35]

#### **2.5.2.5 Microscopic Intelligent-Driver Model (IDM)**

The final car following model that will be presented in this section is the Intelligent-Driver Model (IDM) which was developed in 2002 and presented in [36]. This model is one of the more recent models that have been added to the already large family of car-following models. This model utilizes the same fundamental fact, that preceding models have used, that the acceleration / velocity of the following vehicle is dependent on velocity of the following vehicle, its relative velocity to the lead vehicle and the distance between the two vehicles. However the difference in its formulation and its aim makes it very unique.

The aim of the IDM is to replicate traffic as realistically as possible but without a lot of the parameters, that are costly to calibrate, that are associated with the high fidelity models such as Weidmann's model. The IDM is looking to be as simple as some of the earlier models, with a few parameters that are reasonable to interpret, relevant and that are empirically measured, but model traffic with a much higher level of fidelity than the

earlier models. The IDM is built on the simple assumption that the acceleration of the following vehicle  $\alpha$ , is a continuous function its velocity  $v_\alpha$ , the gap  $s_\alpha$ , between itself and the lead vehicle as well as the difference in velocity  $\Delta v_\alpha$  between itself and the leading car. See equation 2-8

$$\dot{v}_\alpha = a^\alpha \left[ 1 - \left( \frac{v_\alpha}{v_0^\alpha} \right)^\delta - \left( \frac{s_\alpha^*(v_\alpha, \Delta v_\alpha)}{s_\alpha} \right)^2 \right] \quad (2-8)$$

where:

$a$	=	maximum acceleration
$\delta$	=	acceleration exponent
$s_\alpha^*$	=	desired gap
$v_0$	=	desired velocity

The IDM is a compact high-fidelity car-following model with few parameters that are easy to understand and measure; however, there has been no supporting literature to suggest that it has been implemented into a traffic simulator. [36]

Car-following models have greatly evolved over the last of 50 years. They have evolve from being simple models intended for basic investigations with reasonable fidelity to very complex model capable of analyzing a variety of traffic conditions with a high level of fidelity. All aforementioned car-following models, and those not mentioned in this thesis have been very successful at representing the essence of vehicle motion for both microscopic simulation and other analytical purposes. For model details regarding these models please see corresponding citations and for detailed comparisons amongst car-following model please see [37], [38], [39].

There are currently a number of researchers looking to further improve vehicle motion in traffic simulation in order to model traffic more realistically. Much of today's research efforts are focused on increasing the details associated with the dynamic properties of the vehicle, in large part to ensure that realistic accelerations and decelerations. These current research efforts are looking to extend the work started in the Gipps behavioral model and the IDM as they are two earlier models that sought to incorporate *real* vehicle dynamics into their formulation.

### **2.5.3 Advancing Vehicle Dynamics Representation in Traffic Simulation**

In the field of traffic engineering, vehicle movement within traffic simulation is barely influenced by a vehicle's own static and dynamic characteristics. Meaning, the simulation of a car's movement is hardly influenced by, for example its weight, length (static properties) and its acceleration, deceleration capabilities (dynamic properties). Instead, vehicle motion is dictated by a variety of mathematical approximation, chiefly car following models that only capture the essence of the interaction between a following and lead car. These models are meant to replicate commonly observed traffic patterns but they do not take into account the vehicles previously mentioned characteristics. The work presented in [5-7] is looking to abandon that trend.

This set of work presented a vehicle dynamics model which is capable of predicting maximum accelerations of light-duty vehicles while being capable of modeling truck acceleration behavior. This model was specifically produced for use in microscopic traffic simulation as an effort to continue the improvement of vehicle movement representation in traffic simulation and extend the accuracy of current state-of-the-art

acceleration models. What is noteworthy about the model is that it incorporates many aspects of vehicle dynamics that are often times neither insufficiently accounted or neglected by some of the previous models that are meant to represent vehicle motion.

The foundation of the model is that the resulting vehicle dynamics is based on the fact that the *net* force is equal to the product of the vehicle's mass and its acceleration. See equation 2-9.

$$a(t) = \frac{F(t) - R(t)}{M}$$

where:

$F(t)$  = Residual force at instant  $t$  (N),

$R(t)$  = Total resistance force at instant  $t$  (N), and

$M$  = Vehicle mass (kg).

(2-9)

When computing the residual force it is taken as the minimum of the engine's tractive force and the maximum force that can be sustained between the vehicle's tires and the roadway. See equation 2-10.

$$F_{n+1}(t) = \min \left[ 3600 \cdot \eta \cdot \beta \cdot \frac{P}{u_{n+1}(t - \Delta t)}, 9.8066 \cdot M_{ta} \cdot \mu \right]$$

$$\beta = \frac{1}{u_p} \left[ 1 + \min(u_{n+1}(t - \Delta t), u_p) \left( 1 - \frac{1}{u_p} \right) \right]$$

where:

$\beta$  = Variable power factor,

$\eta$  = Transmissions efficiency,

$P$  = Engine power (kW),

$M_{ta}$  = Mass of vehicle on tractive axle (kg),

$\mu$  = Coefficient of friction between tire and pavement, and

$u_p$  = Speed at which vehicle attains maximum power (km/h).

(2-10)

And when calculating the total resistance affecting the vehicle, it is the sum of the aerodynamic, rolling and grade resistances. See equation 2-11.

$$R_{n+1}(t) = c_1 C_d C_h A_f \cdot u_{n+1}^2(t - \Delta t) + 9.8066 M C_r [c_2 u_{n+1}(t - \Delta t) + c_3] + 9.8066 M G \quad (2-11)$$

where:

- $R(t)$  = Total resistance force; sum of the aerodynamic, rolling, and grade resistance forces (N),
- $c_1$  = Constant accounting for density of air at sea level (0.047285),
- $c_2, c_3$  = Rolling resistance coefficients,
- $C_d$  = Vehicle drag coefficient,
- $C_h$  = Altitude coefficient,
- $C_r$  = Rolling coefficient,
- $A_f$  = Vehicle frontal area (m<sup>2</sup>), and
- $G$  = Percent grade (m/100m).

This model is a very comprehensive model not only taking into consideration the limitations of the vehicle itself but also all the significant external forces that will affect the dynamics of the vehicle. This model represents the state-of-the-art of the vehicle modeling for the purposes of traffic simulation.

#### 2.5.4 Vehicle Modeling in Automotive Engineering

Modeling vehicle dynamics, in automotive engineering is at the complete opposite end of the spectrum from traffic engineering. Traffic engineering minimally accounts for vehicle dynamics as traffic streams are considered as waves, vehicle as particles and only recently a few dynamic properties of the vehicle are introduced. Automobile engineering on the other hand is capable of very detailed analysis of how a single vehicle traverses within a transportation facility by varying its characteristics,

static and dynamic, and conditions that are associated with both the vehicle and the environment. During such analyses vehicle engineers have the ability to model all the key components of a vehicle including its tires, suspension, steering and the drive-train. The reasons for doing such detailed analyses range from safety concerns to optimizing the performance of a given vehicle while looking to economically and safely mitigate associated impacts that an automobile may have on the environment.

#### **2.5.4.1 State of Vehicle Modeling in the Automotive Industry**

A number of companies have developed some software packages that are capable of simulating the full range of a vehicle's dynamic properties while performing a variety of analyses. Two of the more well known companies that have been providing this service are the Mechanical Simulation Corporation with CarSim – “a software tool for simulating and analyzing the way cars, light trucks and SUVs respond to steering braking and acceleration inputs” [40], and Systems Technology Incorporated with VDANL (Vehicle Dynamics Analysis, Non Linear) which is “intended for the analysis of passenger cars, light trucks ...(and) is designed to permit analysis of virtually all driver induced maneuvering up through limit performance conditions” [41]. These companies are invested in using a detailed and vehicle-specific simulation and they can offer quite a bit to those working to advance traffic simulation.

Further emphasizing the gap that exists between modeling vehicle dynamics in traffic engineering and automotive engineering an additional use of detailed vehicle modeling will be highlighted. This other application is the development of driving



simulators and vehicle-like robots [42], [43], [44]. Although a number of the aforementioned automotive engineering software packages are capable of accomplishing similar goals with their hardware-in-the-loop capabilities, the additional uses being highlighted here are very specific to tasks. These specific tasks range from driver training and the studying of driver behavior to the investigation and development new vehicle technology.

## 2.6 Summary

The preceding section served to provide the background for this research. In the first few sections of this chapter the focus was on traffic simulation – its history, state-of-the-art and potential next step. A considerable amount of attention was paid to microscopic simulation as it the state-of-the-practice and in order to continue the advancement of traffic simulation a great understanding must be had of the current status of traffic simulation. Despite the many successes of microscopic simulation can only still provide an *estimate* of how traffic behaves due to it core limitation which was also discussed in the preceding sections.

In looking at the future of traffic simulation a nanoscopic prototype was presented with three sub-systems, the driver, the vehicle and the environment, working seamlessly to represent traffic's reality. Given that the focus of this thesis is to present the development of the vehicle subsystem of this prototype, the manner in which vehicle movement is currently being represented in today's traffic simulators was carefully

examined. By way of comparison, the manner in which vehicle motion is presented in the automotive industry was also analyzed.

The future of vehicle movement representation in traffic simulation was also visited and the role of the DIV model highlighted as it would serve to advance a few of the current efforts to improve vehicle representation in traffic simulation.

## CHAPTER 3

### RESEARCH APPROACH

This chapter will highlight the steps taken to develop the DIV model and how it is intended on working to accomplish the set goals of this thesis. This section will also look to provide information as to the model will be implemented and validated.

#### 3.1 Introduction

This section is geared towards presenting the methodology that will be used to develop the proposed Dynamic-Interactive-Vehicle (DIV) model for beyond-microscopic simulation. The DIV model will be built by synthesizing the state-of-the-art techniques and information with respect to the accurate representation of vehicle dynamic properties that the model will utilize. After developing the model it will be implemented with the use of MATLAB/Simulink - a programming tool. Once the model has been developed and implemented the model will then be tested and results evaluated in order to validate the model. This validation process is aimed at ensuring that the model's output will be consistent with the output from a real vehicle within a reasonable margin of error.

#### 3.2 Why Develop the DIV Model

The essence of developing the DIV model is to facilitate more realistic representation in traffic simulation while eliminating the need for expensive and sometimes elaborate calibration processes. Although there are been several high fidelity car-following and “*vehicle*” models in traffic simulation that represent essence vehicle

motion in traffic simulation, they do not adequately account for a few other dimensions that are important to both vehicle movement and the behavior of traffic. These dimensions include acceleration / deceleration performance within corresponding a vehicle's capabilities, effects of the interaction amongst the vehicle, driver and environment and the representation of lateral movement.

### **3.2.1 Acceleration Performance and Vehicle Limitations**

One of the more fundamental dimensions of vehicle motion that a number of car-following models do not adequately take into consideration is the acceleration and/or deceleration capabilities of a vehicle corresponding to its dynamic properties. Instead several of these models approximate maximum and minimum acceleration capabilities according the general behavior of today's vehicle fleet. Although these approximations may be relatively correct for a number of vehicles, there are vehicles that are incapable of performing according to these levels accelerations. As a result the impact that these vehicles will have on a traffic stream are not fully accounted for which leads to the misrepresentation of traffic's behavior. Such misrepresentation can lead not only a lack of confidence when analyzing a traffic behavior but also a lack of confidence in proposed solutions whose developed was aided by the use of traffic simulation.

### **3.2.2 Driver-Environment-Vehicle Interaction**

Another dimension of vehicle motion, and subsequent traffic behavior that some car-following / acceleration models do not sufficiently account for are the involvement of the driver and the environment in a vehicle's motion. Although the basis of many car-

following models is the treatment of the driver and the vehicle as a single unit, they omit some of the effects of the interactions between the driver and the vehicle. Some of these effects include the behavior of the vehicle as the driver moves his or her foot to and from the gas and brake pedals, as well as the behavior of the vehicle as the driver constantly accelerates and decelerate to maintain a desired speed. Another effect due to the interaction between the driver and the vehicle that past models do not sufficiently consider is the fact that at times the driver's desire to, for example, accelerate is sometimes outside of the capabilities of the vehicle. And as a result, the driver desire is not equivalent to the vehicle's performance which is at times the case when the driver and the vehicle are treated as a single unit. As for the effects, due to the interactions between the vehicle and the environment that are not sufficiently treated by previous models, they include lack of adequate representation of how a vehicle moves as it is being affected by the wind, the surface of the road or an incline.

### **3.2.3 Lateral Vehicle Movement**

A key dimension of vehicle motion that nearly all of the previous models have not accounted for is the lateral movement of the vehicle. All the previous car-following and vehicle models in traffic simulation are competent at representing the essence of the longitudinal motion of vehicle but choose not to account for the lateral movement of the vehicles. This is partly due to the fact that in traffic simulation the basic *lateral* movements are already model by lane-changing models and gap-acceptance models. Even though these models provide adequate means of representing a vehicle lateral movement in traffic simulation, they ignore some of the fundamental dynamics of a

vehicle as it, for example, transitions from one lane to the next. The changing of lanes in traffic simulation is represented by *jumps*. These *jumps*, at times, omit the some of the impacts that a lane-change event will have on a traffic stream. And these impacts are especially important to represent as different drivers react very differently to such an event causing a variety of effects on traffic stream.

### 3.2.4 Calibrating Previous Models

The calibration process that usually accompanies the use of some of these past models is often times costly and complicated. The costliness that is at times associated with the calibration of these models may include the monetary value associated with conducting expensive experiments to assign values to particular parameters that are needed to allow the model to output *realistic* values of the situation they are meant to represent. Costliness may also be in terms of man-power and time used to calibrate these models. One of the more substantial reasons for the complexity associated with the calibration process of some of the past high-fidelity car-following models is that they include parameters that do not have a direct linkage to the system that they are attempting to represent. This fact makes determining the values of these parameters more difficult mainly due to the ambiguity of magnitude and / or signage associated with these parameters.

Based on the aforementioned dimensions that are not adequately accounted for in previous car-following and “*vehicle*” models in traffic simulation, the DIV model is being developed to address these issues, while remaining a model that is relatively

inexpensive and easy to calibrate. This DIV model will not only serve to extend the work of these previous models but it will also attempt to represent the beginning of modeling traffic beyond a microscopic level to potentially be used in areas, such as transportation forensics, advanced highway design, more accurate vehicle emission estimation and the development ITS's Vehicle Integration Infrastructure (VII).

### 3.3 Description of the DIV Model

The following will present the framework for the development of the DIV model. This model will aid in the bridging of the gap that exists between the manner in which vehicle dynamics are treated in transportation engineering and automotive engineering. The DIV model will allow for a greater number of vehicle characteristics to be modeled and their effects accounted for when simulating traffic. The vehicle characteristics that the DIV model will incorporate into traffic simulation are associated with the three most important systems that facilitate vehicle movement – the engine / power-train, brake and steering systems. By representing these systems, the DIV model will allow traffic simulation to represent vehicle motion more accurately than with the use of previous techniques that were used to represent vehicle motion.

The DIV model is designed with the capability to accept a driver's input into its three previously mentioned *sub-systems*, allow them to respond accordingly and within their limits, while outputting the corresponding results. By the nature of the design of this model, the output should correspond to the actual output of a vehicle with similar *sub-systems* and inputs. Another noteworthy point with regards to this model is that it will also take into account most of the additional major external forces that impact the

movement of a vehicle within a transportation facility. These major external forces are illustrated in **Figure 3**. These forces include aerodynamic resistance  $R_a$ , the rolling resistance of the front and rear wheels  $R_{rf}$  and  $R_{rr}$ , respectively, the drawbar load  $R_d$ , which is equal to zero for the purposes of the model being developed, and the tractive forces of the front and rear wheels produced by the engine,  $F_f$  and  $F_r$ , respectively. In the case of a front-wheel drive vehicle the tractive force on the rear wheels,  $F_r$ , is equal to zero, while in the case of a rear-wheel drive vehicle the tractive force of the front wheel,  $F_f$ , is equal to zero. Knowing that there are other forces acting on a vehicle and without making the model too complex the DIV model will not include dynamic features whose impact on vehicle motion is often negligible. [45]

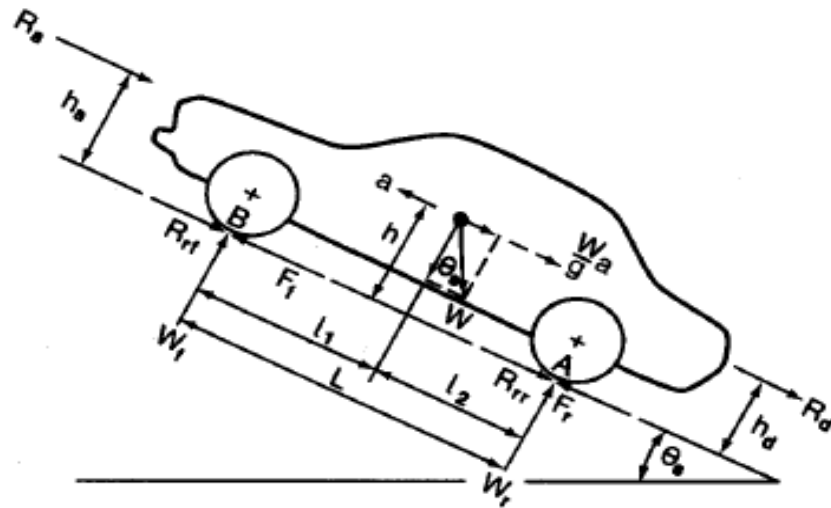
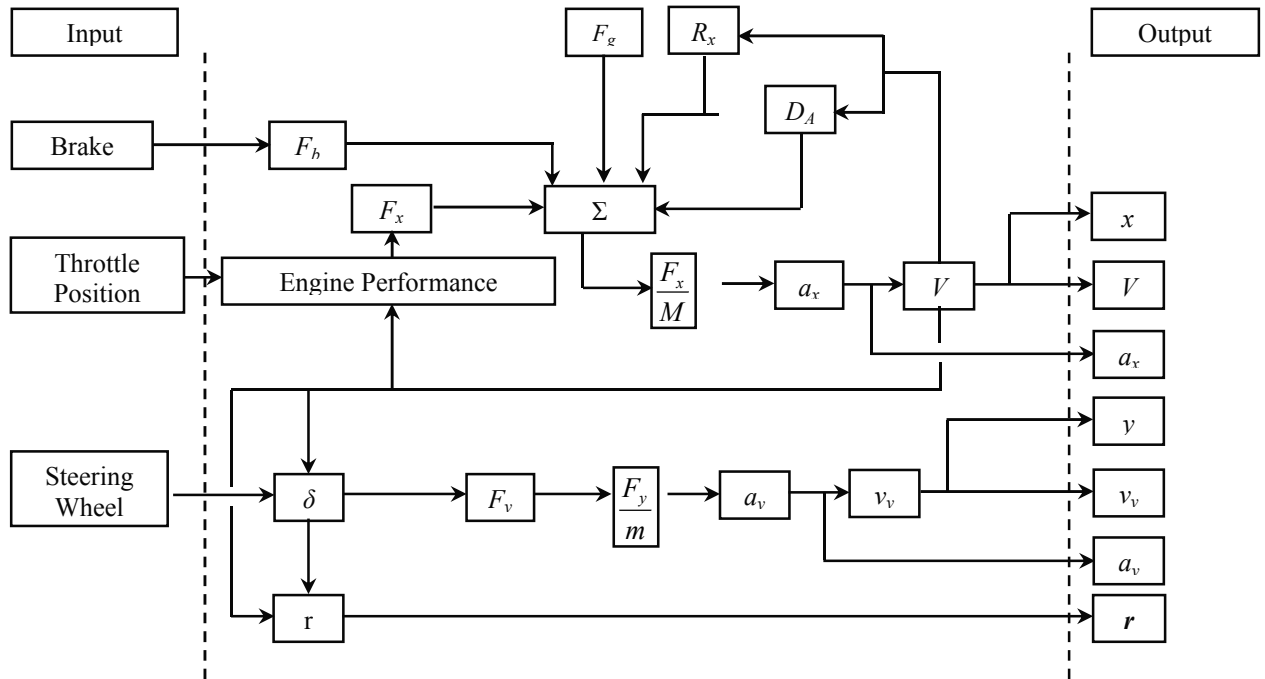

**Figure 3 - Forces acting on a two axle vehicle [45]**

In developing the DIV model a transfer diagram, illustrated by **Figure 4**, was created to illustrate the inner-workings of the model. This diagram illustrates all the key features of the DIV model and their anticipated interaction with each other. The transfer diagram also presents the essential logic of the model by presenting the path that a set of



input parameters will take to give a particular set of output features. As one can see from **Figure 4**, the driver will interact with both the brake and engine sub-systems to produce forces that will eventually be summed with other forces, such as the aerodynamic and rolling resistances to produce a resultant force in the longitudinal direction. This longitudinal force will be responsible for the vehicle's acceleration, velocity and position in the  $x$  - *direction*. An additional point to note here is that the DIV model does have a feedback feature to it as the vehicle's velocity is feed back to the power-train sub-system to produce the longitudinal force for the next iteration, just as how it occurs in reality. Just as how the driver will interact with the brake and engine sub-system, the driver will also interact with the *steering mechanism* to allow the movement in the lateral direction to be represented by the DIV model in conjunction with the dynamics of x-direction. Here again the DIV model's feedback feature come into play as the vehicle's speed is fed back into steering-sub-system to facilitate accurate representation of the vehicle's position in the global X-Y plane.



#### Nomenclature

$a_x$	Acceleration in the x-direction	$M$	mass of the vehicle
$a_y$	Acceleration in the lateral direction	$r$	Yaw velocity about the z-axis of the vehicle
$D_A$	Aerodynamic drag force	$R_x$	Rolling resistance force
$F_g$	Force due to Gravity	$V$	Forward velocity
$F_b$	Braking force	$v_y$	lateral velocity
$F_x$	Force in the x-direction (tractive force)	$x$	Forward direction, vehicle's longitudinal axis
$F_{xt}$	Total force in the x-direction	$y$	Lateral direction out the right side of the vehicle
$F_y$	Force in the y-direction (lateral force)	$\delta$	Steer angle

**Figure 4 - Schematic Base of the Dynamic-Interactive-Vehicle Model**

As previously alluded to, one of the key features in developing the DIV model is its capability to accept input from a driver. What is noteworthy here is that this *driver* can either be the AID model, as proposed by [24], or a *real* driver. Another key aspect of the DIV model is that the output is designed to reflect an actual vehicle's path through a transportation network as well as its speed and acceleration at various instances within the network.

### 3.4 Implementation of the DIV Model

When implementing the DIV model, the GUI (Graphical User Interface) software programming tool MATLAB/Simulink will be the platform used due to its user friendliness and efficiency. This package, in addition to facilitating the possibility to, essentially, implement the above transfer diagram into computer code, also enables the use of some prepackaged mathematical tools. The said mathematical tools or blocks are available to represent not only mathematical functions, with varying complexity, but also vehicle components, such as vehicle suspension, tires, etc., and *sub-systems* that can be tailored for particular usage. Such an opportunity will allow for both the efficient implementation of the model and also an increase in the model's reliability.

A key aspect of the implementation process is the manner in which the DIV model will be driven through its input interface. The general idea is that the driver will have numerical desire when activating any of the vehicle's sub-systems. The numerical desire will exist within the range 0 and +1 or -1 and +1, inclusively, depending on the particular input device. Using the accelerator and its relationship with the throttle position as an example, 0 represents a minimum desire where the driver has no desire to accelerate, while 1 represents a maximum desire to accelerate which corresponds to the driver displacing the accelerator to allow the throttle to let through the maximum amount of air to the engine to make the engine go faster.

In addition to taking such care when dealing with the input, and subsequently the output – as it has to output measures that are similar to those of a *real* vehicle, special care will be taken when feeding back a few of the parameters into the model. All in all, despite the power of the available programming tool and the most reliable and state-of-

the-art vehicle dynamics literature; the implementation process will try to balance accurate detail in the model without losing its ability to faithfully represent the vehicle. This balance is especially important since one of the goals of developing this model is to allow it to partake in real-time simulation integration.

### **3.5 Calibration and Validation of the DIV Model**

After successfully implementing the DIV model by using the desired programming software package (MATLAB/Simulink), it will then be debugged and prepared for the next step towards its completion. The next step in the formulation of the proposed DIV model is to calibrate and validate the model.

#### **3.5.1 Model Calibration**

One for the key design features of the DIV model is that it is meant to be easily and cheaply calibrated. The calibration process of the DIV model will entail the user outfitting the model with the specifications of the vehicle that the user is looking to model. These specifications will be assessable as they are available to the public via car manufactures and various organizations that offer tools to research a myriad vehicles, for example Cars.com. The vehicle specifications that the DIV model requires include:

- aerodynamic resistance coefficient
- engine displacement
- gear & steer ratios
- height
- width
- weight
- wheel base
- wheel radius

In addition to these vehicle specifics, the model also has a few variables relating to the environment that has an impact on vehicle motion. Such variables include wind speed and gradient of the roadway. Once the specifics of the vehicle and the various values describing the surrounding are inputted in the DIV model it will be able to replicate the motion of the vehicle that these specifications belong to. The calibration process for the DIV model can afford to be this simple largely due to the fact that the DIV model represents the basic processes that contribute to the dynamic properties of an automobile.

One of the primary ways the DIV model does this is that it models how an engine works by capturing all the essential interactions of the components of the engine and how they produce the driving force for an automobile. The engine model accounts for force produced by the mimicking, as close as possible, how the internal combustion engine works to produce a force to propel a vehicle. Similar approaches were taken when representing the various subsystems of the automobile, with expectation of the brake system.

The brake system is one of the more complicated aspects of an automobile to model and in keeping with the aim of allowing the model to be user friendly, and as uncomplicated as possible, the DIV model chosen as alternate means of representing the brake system of an automobile. This alternate means of representing the brake system of an automobile as it is based on study commissioned by the National Highway Safety Bureau and aided is the establishment of standards for braking system being installed by automobile industry [46]. Greater details of this study and how it was incorporated by the DIV model will provided in the following chapter.

### 3.5.2 Model Validation

The process of validating the DIV model is the process by which the model is tested to determine whether or not it accomplishes the goal of accurately replicating vehicle movement. After the DIV model has been outfitted with all the necessary values associated with the vehicle and the environment, the model will be ready to be tested and its results evaluated. Once the results have been evaluated, the analysis will determine how well the DIV model is capable of replicating the movement of the vehicle whose specifications it has been outfitted with.

The tests that will be used to aid in the validation process of the DIV model include acceleration, braking and turning movement performance tests. The output from the DIV model, after performing these simulated tests, will then be compared to the results of a *real* car whose results from performing similar tests have been published. A few reasonableness tests will also be conducted to ensure that the model behaves well outside of the aforementioned tests which are geared toward testing maximum / minimum performance capabilities. This set of reasonableness tests will verify that the output from the DIV model will correspond to its input not only intuitively and in line with the vehicle's capabilities but also according to physical principles and limitations. In essence, this step is to ensure that the vehicle will not be capable of accelerating from 0 – 100 mph in 2 seconds, which is very impractical for today's standard automobile to do. More details regarding the validation process will be presented in later chapters.

### 3.6 Summary

The previous sections described the DIV model, briefly outlined how it is going to be formulated and steps that will be taken to validate the model. The following chapters will detail this formulation process and discuss how the DIV model will be implemented using MATLAB. Following the description of the implementation process of the model, the model's validation process will be presented.

## CHAPTER 4

### DEVELOPMENT OF THE DIV

This chapter presents all the details of the formulation of the DIV model. All the necessary mathematical equations and assumptions associated with the three primary systems (engine / power-train, brake and steering) essential to the movement of an automobile.

#### 4.1 The DIV Model

The DIV model is an opened ended system that is made to be able represent an automobile and its motion. This DIV model is capable of accepting inputs from a driver and the environment while providing output to these same components according to their respective inputs and the vehicle's specifications that it is attempting to represent. In developing the DIV model, both the static and dynamic properties of a vehicle will be incorporated to allow the model to mimic a vehicle as realistic as possible with minimal complexity. The static characteristics that the proposed vehicle model is looking to incorporate include weight, frontal area, steering and gear ratios to name a few. As for the dynamic properties that will be included in the model representation of vehicle movement, it will take into consideration the predominant forces that act upon a vehicle to influence its motion. Such forces include rolling and aerodynamic resistances, the force produced by the engine and the braking system, and the gravitational force (which is dominant on inclines).



As for the interactive aspect of this model – it will be capable of accepting three inputs that a driver *gives* to a vehicle – throttle position, brake pedal position and the steering angle. The manner in which the model will treat these input is to relate each to a particular desire that a driver may have and represent these various desires on a scale of 0 – 1 for the throttle and brake positions and -1 to +1 for the steering angle. Each of these parameters will then be attached a variable hardwired into the model to account for how they produce their intended effect on a vehicle. For instance, with the driver’s desire to accelerate he or she will apply pressure to the gas pedal which affects the opening of the throttle valve which then dictates the amount of fuel being passed to the engine and the subsequent force that provides the forward motion to the vehicle.

This chapter will detail the various aspects of the DIV model, highlighting the vehicle characteristics that will be incorporated. Central to this model is its ability to accept the three aforementioned inputs, from a driver, and output the corresponding dominant dynamic properties that are associated with vehicle motion. These properties include the vehicle acceleration, velocity and distance covered in the direction of travel (the x-direction). Additionally, the vehicle’s position in the x-y plane will also be an output which means that the vehicle’s lateral motion will also be taken into consideration – which unique to the field of vehicle dynamics being represented in transportation engineering.

The following sections will present forces how the DIV model treats various components of the vehicle in order to capture the corresponding effects on vehicle motion. These components include the engine, the braking system and the steering mechanism. The details of how the DIV-model will account for a few *secondary* effects,

such as rolling resistance, air resistance and the effect due to gravity will also be presented in the following sections.

## 4.2 Representing Longitudinal Movement

### 4.2.1 Equation of Motion of a Two Axle Vehicle

Previously mentioned in Chapter 3, forces in the  $x$ -direction that the DIV model is looking to take into account are the forces due to the engine and the braking system, rolling and aerodynamic resistances and the force due to gravity. See 4-1 for an illustration of how these forces act on a two axle vehicle.

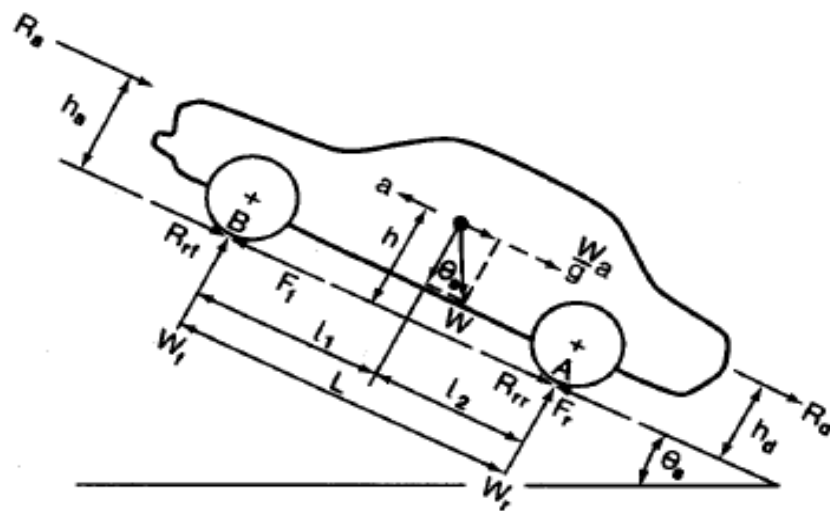

Figure 5 - Forces acting on a two axle vehicle [45]

The equation of motion such a vehicle can be derived by using **Figure 5**, along with Newton second law of motion, which states that, observe from a inertial frame of reference the net force acting on a body is proportional to the rate of change of it linear momentum. With linear momentum being the product of the body's mass and its

velocity, Newton second law of motion is often time stated as the sum the forces acting on a body is equal to the product of the body's mass and its acceleration. See equation.

4-1. [47]

$$\sum F = ma \quad (4-1)$$

Apply equation 4-1 to a two axel vehicle, its equation of motion is

$$\sum F = ma = \frac{W}{g} a = F_f + F_r - F_b - R_a - R_{rf} - R_{rr} - R_g \quad (4-2)$$

where:

- $W$  = Weight of the vehicle
- $g$  = acceleration due to gravity
- $F_f / F_r$  = Tractive force produced by the engine ( $F_f$  or  $F_r = 0$  depends vehicle)
- $F_b$  = Force produce by the brake (N)
- $R_a$  = Aerodynamic Resistance (N)
- $R_{rf} + R_{rr} = R_r$  = Total tire rolling resistance (N)
- $R_g$  = Grade resistance (N)

The following sections will provide details of how each of theses forces is determined by the DIV model.

#### 4.2.2 Force produced by the engine

The engine model that will be incorporated in the DIV model was adapted from the model presented in [48]. This model manages to successfully represent the complexity of the inner working of an internal combustion engine in a very simple and straight forward manner. At the base of this model uses an analytical approach which looks at interaction at between the gas pedal and the force produced by the engine body.

The essence of this approach is that when the driver applies pressure to the gas pedal, the orientation of the throttle valve changes. The change in orientation determines the amount of air flowing into the inlet manifold. The fuel injector then release fuel in a quantity that corresponds to the amount of air flowing through the inlet manifold. This combination of air and fuel is then passed into the cylinders of the engine block, which then combusts, due to a spark from the spark plug. This combustion produces a force on the crankshaft, which then *flows* through the power-train of the vehicle causing the wheel of the vehicle to turn. **Figure 6** provides an illustration of the principle of the engine model developed in [48].

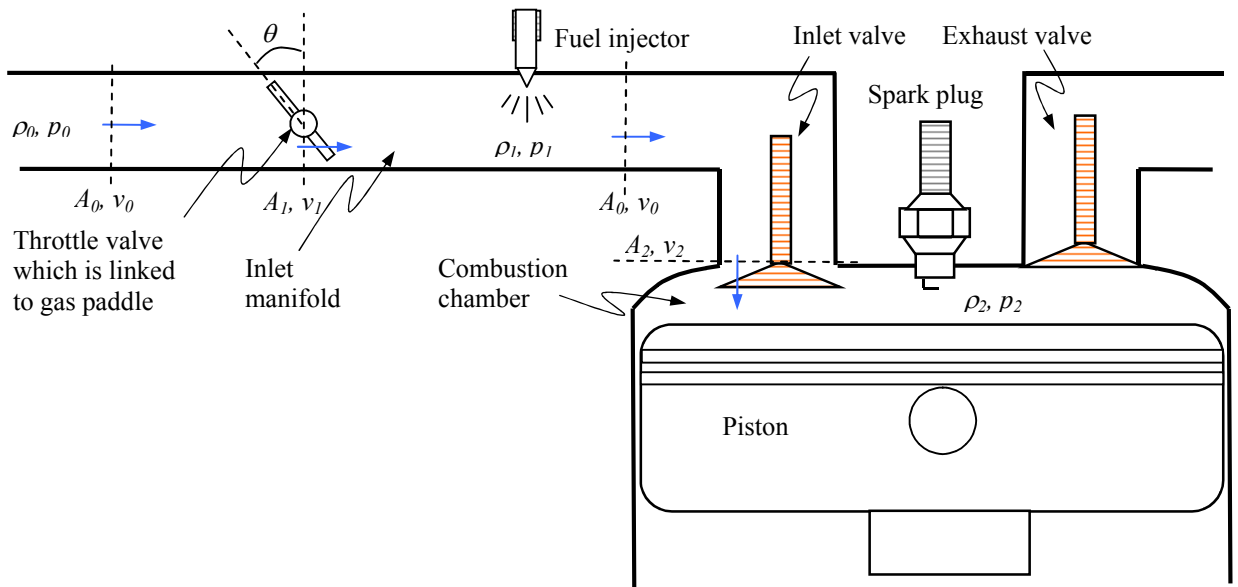

**Figure 6 - Key Components of an Engine's Fuel Injector System**

From the above mentioned approach, the key to replicating how an engine works to produce a force that propels a vehicle forward is the amount of fuel being injected in the engine block. But in order to determine the amount of fuel being inject to amount of air flowing in the inlet valve must first be determined. The mass of air flowing into the engine's cylinders,  $m_a$ , is equal to the following:

$$m_a = \rho_2 \cdot V_a \quad (4-3)$$

where:

$\rho_2$  - density of the air in the combustion chamber

$V_a$  - Total volume of the air in the combustion chamber of the engine

However  $\rho_2$  and  $V_a$  need to be calculate first. The volume of air in all the combustion chambers of the engine,  $V_a$ , is essentially the product of the engine's displacement / volume and its speed; resulting in:

$$V_a = V_e \cdot \frac{1}{2} \cdot \frac{\omega}{2\pi} \quad (4-4)$$

where:

$V_e$  - engine displacement (m<sup>3</sup>)

$\omega$  - engine speed (rad/s)

As for the density of air is the combustion chamber,  $\rho_2$ , it was calculated based on the Bernoulli's Principle which, in essence states that an increase in the speed of a fluid results in a decrease in the pressure or gravitational energy experience by that fluid as long as there no work being done on the fluid. In calculating  $\rho_2$  the cross-sectional areas of the inlet manifold and the opened throttle along with their respective air pressure and densities were used. Therefore after several iterations:

$$\rho_2 = \rho_0 - \frac{\rho_0^2 V_a^2}{2 A_0^2 p_0} \left( \frac{1}{\theta} + \frac{A_0^2}{A_2^2} - 2 \right) \quad (4-5)$$

where:

- $A_0$  - cross-sectional area of the inlet manifold (m<sup>2</sup>)
- $A_2$  - cross-sectional area of the inlet valve (m<sup>2</sup>)
- $\rho_0$  - density of air flow before the throttle (kg/ m<sup>3</sup>)
- $p_0$  - air pressure before the throttle (N/ m<sup>2</sup>)
- $\theta$  - throttle position (percent of throttle opening)

After computing the mass of air being taken into to the engine block the corresponding amount of fuel maybe estimated using the Stoichiometric air-fuel ratio ( $\lambda$ ) for gasoline, which is 6.8% (fuel by weight). Having a value for the amount of fuel entering the engine, the amount of power that maybe generated by this quantity of fuel can be determined by using the energy fuel density of gasoline,  $E_f$ , which is 46.9 MJ/kg. It is known that the efficiency of an internal combustion engine,  $\eta$ , is not 100% and as a result corresponding calculations have to take this fact into account. The effective power,  $P_{eff}$ , the power that will be delivered to the vehicle's powertrain mechanism is defined as:

$$P_{eff} = \eta \lambda E_f m_a \quad (4-6)$$

With the effective calculated the effective torque,  $P_{eff}$ , delivered to the wheels of the vehicle can be determined with the following relationship.

$$T_{eff} = \frac{P_{eff}}{\omega} \quad (4-7)$$

And from the effective torque being delivered to the wheel, the effective force,  $F_e$ , produce by the engine to promote vehicle motion can therefore be calculated with the aid of the appropriate final transmission gear ratio,  $N_{ft}$ , and wheel radius,  $r$ .

$$F_e = \frac{T_{eff} \cdot N_{ft}}{r} \quad (4-8)$$

The above sections provide a summary of the engine model proposed in [48]. For more details regarding the development of the engine model being incorporated in the DIV model, they can be had by referring to the aforementioned citation. **Figure 7** provides a graphical representation of the basis of the aforementioned engine model to be incorporated in the DIV model.

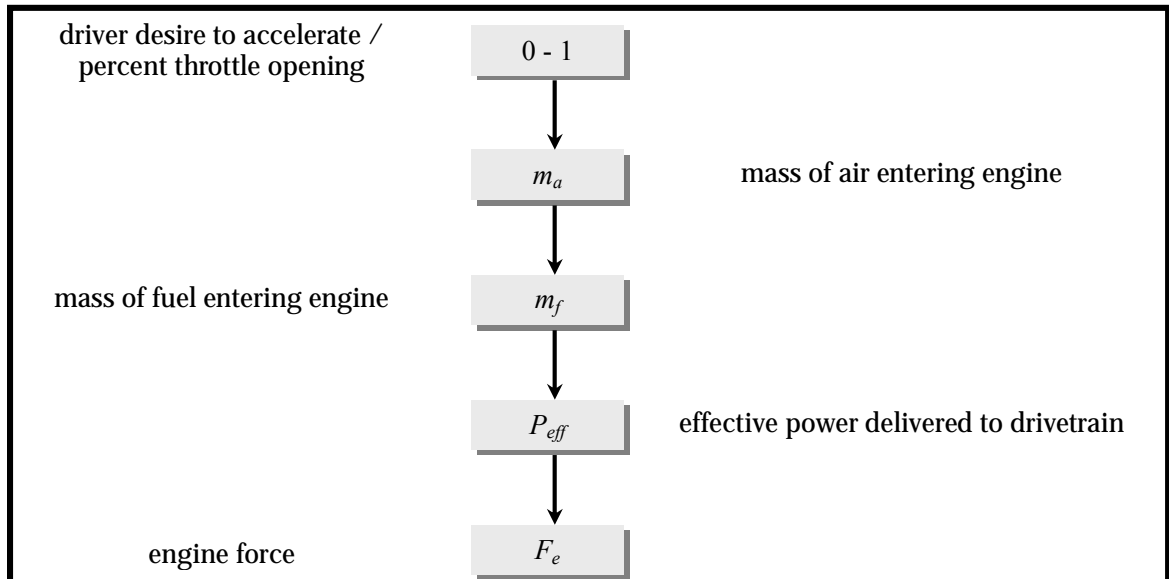

**Figure 7 - Principle behind the engine force and the corresponding driver interaction**

### 4.2.3 Force produce by Braking System

Given the scope of the task at hand, the DIV model will look to represent a vehicle's braking capabilities in a different fashion as was done with the representation of the capabilities of a vehicle's engine. In representing the engine capabilities of an automobile the DIV model used several of the engine's design specifications. This allowed the DIV model to be tailored to represent a variety of vehicles, in part - satisfying the flexibility criterion of DIV. The DIV model needs to be flexible when accounting for the engine of an automobile as engine performance has tremendous variability from one vehicle to the next. The brake system on the other hand does not have the level of variability that is needed to account for its performance by using the design specifications of vehicle's braking system. Instead the brake system will be represented by equating the force being applied to the brake pedal by the driver to the corresponding deceleration of the vehicle. This means of representing the braking ability of a vehicle was as a result of the work presented in [46], sponsored by the National Highway Safety Bureau

The objective of the work done in [46] was to define those brake characteristics, within the space bounded by the relationship between brake pedal force and vehicle deceleration, which lead to acceptable driver-vehicle performance. In essence this study was done to determine ergonomic properties for brake pedals that would give drivers the most effective control [49]. Therefore, using the results from this study the DIV model



will be able to not only account for the braking performance of the vehicle but also the manner in which the driver interacts with the system.

The results of the aforementioned study include several linear relationships which describe the force being applied to the brake pedal and the rate of deceleration of the vehicle. **Figure 8** provides a graphical summary of the linear relationships derived from this study.

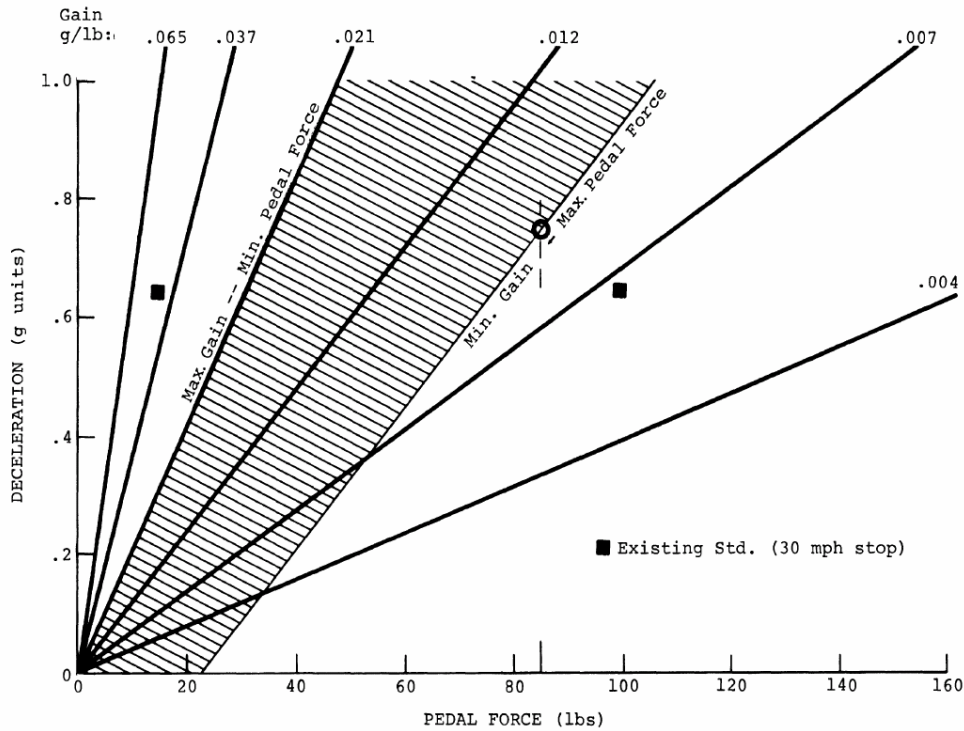

**Figure 8 - The recommended deceleration/pedal force space [46]**

From the above relationships, the DIV model will use the proportionality constant which provides optimal pedal force gain. This proportionality constant, 0.021 g/lb, corresponds to maximum deceleration rate through minimal pedal force. Using this proportionality

constant, the following formulation will be used in the DIV model to represent the brake system of a vehicle and the driver's interaction with that system.

$$D_x = d_{brk} \cdot p_f \quad (4-9)$$

where:

$$\begin{aligned} D_x &= \text{longitudinal deceleration (g)} \\ d_{brk} &= \text{driver's desire to brake (0-1)} \\ p_f &= \text{pedal-force gain coefficient} \end{aligned}$$

From the Eq. (8) the braking force, in Newton, as a function of the pedal force being delivered by the driver is

$$F_b = 4.4 \cdot d_{brk} \cdot W \quad (4-10)$$

Similar to the treatment of how the driver causes the engine to produce a propulsion force through the desire to accelerate, so will the driver be able produce a force to retard the vehicle's motion through the desire to decelerate. The driver will have a desire ranging from 0 – 1 which will correspond to the amount of force that the driver applies to the brake. The corresponding range for the amount of force being place on the brake by the driver is 0 - 48 lbs. Therefore upon establishing the driver's desire, the corresponding pedal force will be used in Eq. (9) to obtain the braking force that will retard the motion of the vehicle. See **Figure 9** for illustration of the above principle.

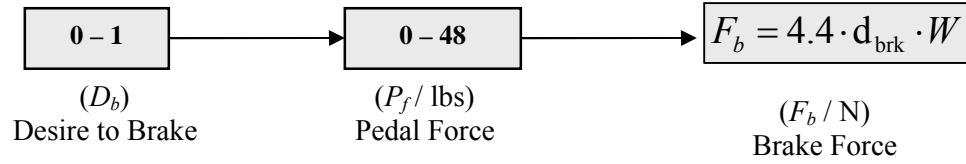

**Figure 9 - Principle behind the driver’s desire to brake and the accompanying force**

#### 4.2.4 Force due to Rolling Resistance

Rolling resistance is essentially the force that is experienced when an object rolls along a surface. In the case of the DIV model, the objects are the tires of a vehicle and the surface being the road. The simple equation that defines the rolling resistance is

$$R_r = f_r W \quad (4-11)$$

where:

$$f_r = \text{rolling resistance coefficient}$$

Although this may seem to be a fairly simple relationship, determining the exact value of  $f_r$  is an arduous task due the amount of variables that influence it value. For the case of the model being proposed, the formulation presented in [45] will be used to obtain the value of  $f_r$ .

$$f_r = 0.0136 + 0.40 \times 10^{-7} V^2 \quad (4-12)$$

The above formula is specific to radial-ply tires as they represent the larger majority of the tires that are used on passenger cars today. Although bias-ply tires are also used, the percentage of passenger cars using these types of tires coupled with the minimal

difference in its value of the rolling resistance coefficient, using equation tire is sufficient to aid in the DIV attempt to account for the effect of the rolling resistance on an automobile. What is noteworthy here is that, although the above representation is more accurate at speed up to approximately 100 mph, for the intents and purposes of the DIV model, using the above formula serves as a suitable approximation.

Now with this relationship in place Eq. 11 may now be rewritten to give the force produced by the rolling resistance of an automobile's tires.

$$R_r = (0.0136 + 0.40 \times 10^{-7} V^2)W \quad (4-13)$$

#### 4.2.5 Force due to Aerodynamic Drag

Aerodynamic drag is another force that serves to retard the motion of a motor vehicle. This force is dependent of on atmospheric conditions, the frontal area of the vehicle and the velocity of at which the vehicle is traveling relative to the wind. The equation below further describes how the factors affect the aerodynamic drag, [45]:

$$R_a = \frac{\rho}{2} C_D A_f V_r^2 \quad (4-14)$$

Where:

$\rho$	=	Mass density of the air (0.07651 lb/ft <sup>3</sup> - performance test condition)
$C_D$	=	Coefficient of aerodynamic resistance
$A_f$	=	Frontal area of the vehicle
$V_r$	=	Speed of the vehicle relative to the wind.

#### 4.2.6 Force due to Gravity

The force due to gravity is mainly experienced when the vehicle is on an incline. This force may either retard the vehicle motion or allow the vehicle to accelerate. The effect that this force will have on the vehicle's motion is depends on whether or not the vehicle is traveling up or down the incline. The force due to gravity that is acting on the vehicle is calculate by, [49]:

$$F_g = \pm W \sin \theta \cong W \theta \quad (4-15)$$

where:

$$\theta = \text{Grade of the incline in radians}$$

The above sections summarized all the forces in the x-direction that the DIV model will take into account in its attempts to replicate a vehicle's motion.

#### 4.3 Representing Lateral Motion

The following section will detail the manner in which the motion of the DIV model will be represented in the X-Y plane. Previous sections have highlighted how the model treats the various forces in the x-direction and subsequently the vehicle motion in the x-direction. The DIV model will look to represent motion in the y-direction with the aid of the forces that are accounted in the x-direction, the input of vehicle's steering angle – determined by the driver and the use of non-holonomic constraints on the vehicle.

Structure used to represent the movement of the DIV model in the X-Y plane was adapted from [50] – which included the formulation kinematics and dynamic framework to model a vehicle motion in a two-dimensional space. The kinematics framework that was presented in the aforementioned manuscript was chosen for the DIV for two primary reasons 1) all the pertinent dynamic properties of the vehicle were already accounted by other means in the DIV model and 2) the ease of use with accurate x-y representation.

At the base of the kinematics framework for 2-D representation of vehicle motion is the treatment of the vehicle as a non-holonomic system, which is a system that does not guarantee return to its original position even if its original (internal) configuration is reached. Along with the non-holonomic treatment of the vehicle, comes non-holonomic constraints which are related to the velocity of the vehicle and are held under the assumption that there is no slippage at the wheel during a turn. The assumption that there is no slippage is predominantly applicable to instances of high speed cornering and wheel slippage of low speeds (parking lot speeds) is negligible. The general form of the non-holonomic constraint may be represented as

$$\dot{x} \sin(\varphi) - \dot{y} \cos(\varphi) = 0 \quad (4-16)$$

Where  $x'$  and  $y'$  represent the velocities in the  $x$  and the  $y$  direction in the vehicle coordinate system and  $\delta$  is the vehicle orientation with respect to the global X-Y coordinate system. See **Figure 10** for an illustration of the coordinate system being used and also the *definition* of the various variables that will be used in this segment and by extension the DIV model.

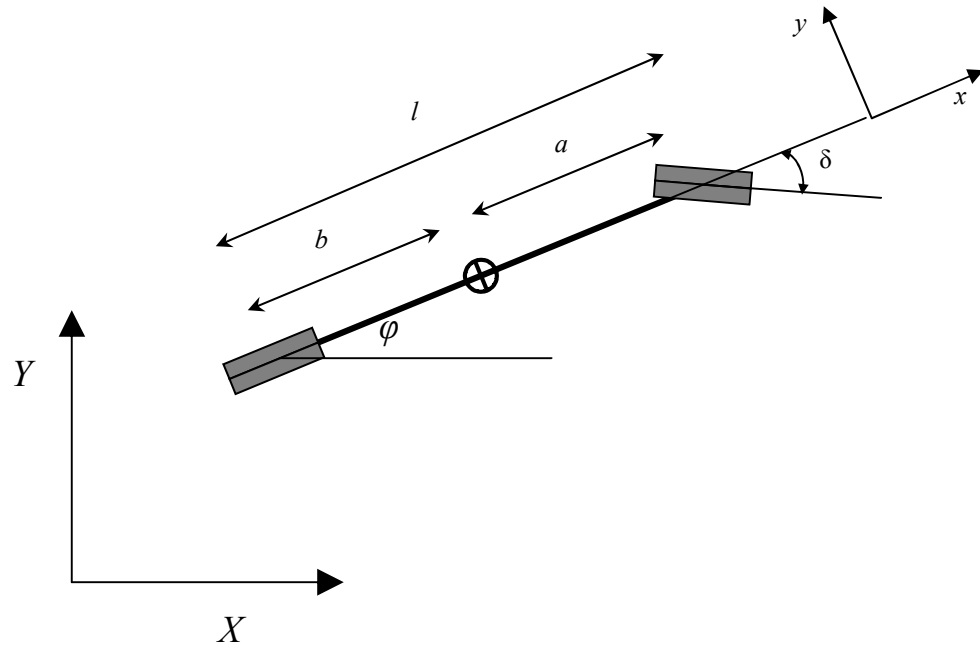

**Figure 10 - Description of the coordinate system and other variables used**

After a few more iteration of equation 4-16 the velocity of the center of gravity with respect to the global coordinate system is defined as:

$$\begin{aligned} \dot{X} &= \dot{x} \cos(\varphi) - \dot{y} \sin(\varphi) \\ \dot{Y} &= \dot{x} \sin(\varphi) + \dot{y} \cos(\varphi) \end{aligned} \quad (4-17, 18)$$

Having equation 4-17 and 4-18 the global position of the vehicle can now be determined. However, before these equations can be used lateral velocity,  $y'$ , has to be first defined and definition of the Ackerman angle,  $\delta$ , also has to introduced as this is the parameter that is responsible for change the orientation of the vehicle.

$$\begin{aligned} \dot{y} &= \dot{\phi}b \\ \dot{\phi} &= \frac{\tan(\delta)}{l} \dot{x} \end{aligned} \quad (4-19, 20)$$

The above formulation provided a summary of the kinematic structure which is used by the DIV model to represent the motion of the vehicle in the X-Y plane. For a complete description of this kinematic framework used by the DIV model see [50].

Having obtained the relationship between the vehicle representation in the X-Y plane and the Ackerman angle, the manner in which the driver will partake in this relationship in order to maneuver the vehicle will now be demonstrated. Similar to how the driver interacted with the engine and the braking system, he or she will have a desire to turn. This desire, unlike the desires to accelerate and brake, will look to take values between -1 and 1 – accounting for the ability to take left and right turns. This desire will correspond to the driver dialing an amount of degrees with the steering wheel. The relationship between the driver's desire, the amount of degrees that will be dialed, and the corresponding Ackerman angle is determined through the manufacture's specifications of the steering mechanism of the vehicle. This relationship is defined as the following:

$$\delta = d_{turn} \cdot \frac{\pi \cdot lck - lck}{S_{ratio}} \quad (4-21)$$

where:

- $\delta$  - Ackerman angle (radians)
- $d_{turn}$  - Driver's desire to turn (-1 to +1)



$lck\_lck$  - # of steering wheel revolutions from one lock to the next  
 $S_{ratio}$  - Steer ratio (ratio of radians dialed to Ackerman angle)

#### 4.4 Summary

The previous chapter served to present all the relevant theory that constitutes the DIV model. All the essential mathematical equations and assumptions associated with the primary systems responsible for a vehicle's motion were highlighted in the previous chapter as they were chosen to capture all necessary dynamics linked to the motion of an automobile in the DIV model. All these details, relating to how the various components of an automobile will be treated in the DIV model will be programmed into MATLAB for analysis and evaluation.

## CHAPTER 5

### VALIDATION OF THE DIV MODEL

The following section will present procedure used to validate to DIV model. This validation process is geared toward determining how accurately the DIV model replicates a vehicle's acceleration, braking and steering performance. Both quantitative and qualitative evaluations will be conducted on the as a part of this validation process.

#### 5.1 Measures Used Validate the DIV Model

In validating the DIV model, three standard performance tests will be used to determine whether or not the DIV model is capable of successful replicating the dynamics of a vehicle it is attempting to represent. These tests that are typically conducted on new vehicles to determine how well they accelerate, brake and handle. Similar tests will be conducted using the DIV model, after it has been outfitted with the properties of a particular vehicle. The output from the DIV model, after completing the aforementioned performance tests, will be compared to values produced by the actual vehicle that the DIV model it attempting to represent. Based how well the output of the DIV model matches up with the performance results of the actual vehicle that will determine whether or not the DIV model is successful at representing vehicular motion.

To test how well a vehicle accelerates, the time it takes for a vehicle to get from rest to 60 mph is often recorded, as well as the time it takes a vehicle to cover a distance of an quarter of a mile (1320 feet). As for determining how well a vehicle brakes there are several standards, dictating maximum allowable stopping distances from various

speeds, under various conditions, which are set by the Federal Motor Carrier Safety Administration that all vehicle manufacturers must satisfy. And finally, in terms of attaching a measure to how well a vehicle handles, the diameter of the circle scribed by the vehicle's outer front wheel is often reported, after the maximum steering angle has been dialed.

Details of the performance tests representing these three aspects of a vehicle's movement will be presented in the following sections. The results from these performance tests produced by *real* vehicles or preset federal standards and then compared to the output of the DIV model after being outfitted with the specifications of the vehicle being analyzed.

### **5.1.1 Test Vehicles for Validating the DIV Model**

The following sections will attempt to validate the DIV model using the specifications and performance results from a series of passenger cars. To increase the applicability of the DIV model, passenger cars were chosen as they represent approximately 58% of the registered passenger vehicles in the United States in 2004 [51]. Therefore, upon successful validation of the DIV model, with the use of passenger cars, the DIV will be capable of representing the majority of vehicles of today's roadways. Three different types of passenger cars were used in this validation process – a sports car, a large passenger car and a small passenger car. The 2006 Porsche Cayman S was the first vehicle to be analyzed. The validation process of this automobile will be presented in much greater details than the other two that will be used to aid in the validation of the DIV model. Providing the details of the validation process does not only permit one to

see how well the DIV model performs in comparison to an actual vehicle but also to get an incite as to how legitimate the validation process really is. The other two vehicles that will be used to aid in the validation process of the DIV model are the 2006 Ford Fusion Sedan SE, the large passenger car, and the 2006 Honda Civic Coupe EX, the small / compact passenger car.

The acceleration and braking performance, along with the lateral movement analysis of the 2006 Porsche Cayman S and the DIV model of this automobile will be presented and the two sets of results compared to each other. A summary table of these will also be provided at the end the analysis to provide a snapshot of how well the DIV model of the Porsche represented the dynamics of the *real* Porsche Cayman. A similar table will be presented summarizing how the DIV model represented the selected vehicle dynamic properties of the Ford Fusion and the Honda Civic.

## **5.2 Validating Acceleration Performance**

### **5.2.1 The Acceleration Performance Test**

As previously mentioned, the tests chosen to verify how well the DIV model replicates the acceleration performance of an automobile are the 0 – 60 mph test and the ¼ mile test. In these test driver of the vehicle opens the throttle body to its maximum position and the time it takes the vehicle to get from rest to 60 mph, as well as the time taken for the vehicle to cover a distance of a ¼ of a mile are recorded. The vehicles tested with this model are automatic vehicles; as a result the DIV model conducts gear

changes as function of the vehicles' speed. However the slight lag that generally occurs as a vehicle change from one gear to the next is not accounted for in the DIV model.

### 5.2.2 The Test Results

According to [52] the 2006 Porsche Cayman S accelerates from 0 – 60 mph in 5.15 seconds and is capable of covering a quarter of a mile in 13.67 seconds. The Porsche Cayman S has a 3.4 liter engine with 6 cylinders and 24 valves. Maximum horsepower (295 hp) is achieved at 6200 rpm while maximum torque, 251 lbs-ft, occurs at 4,400 rpm.

Upon placing all the necessary specifications of Porsche Cayman S in the DIV model, the DIV model was capable of replicating the aforementioned acceleration measures with a high level of confidence. The DIV model representation of the Porsches Cayman S output a time of 4.98 seconds for accelerating from rest to 60 mph. As for the time it took the *vehicle* to cover a distance of a quarter mile (1320 feet) the model's output a time of 13.20 seconds. For an illustration of the above results, see **Figure 11 - 13** which illustrates the throttle input, speed and distance against time, respectively.

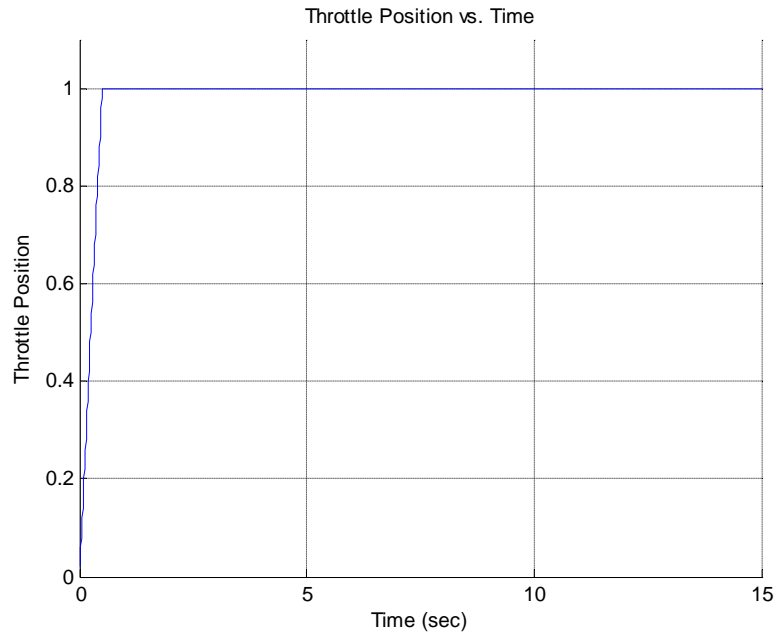

**Figure 11 - Input – Throttle Position vs. Time**

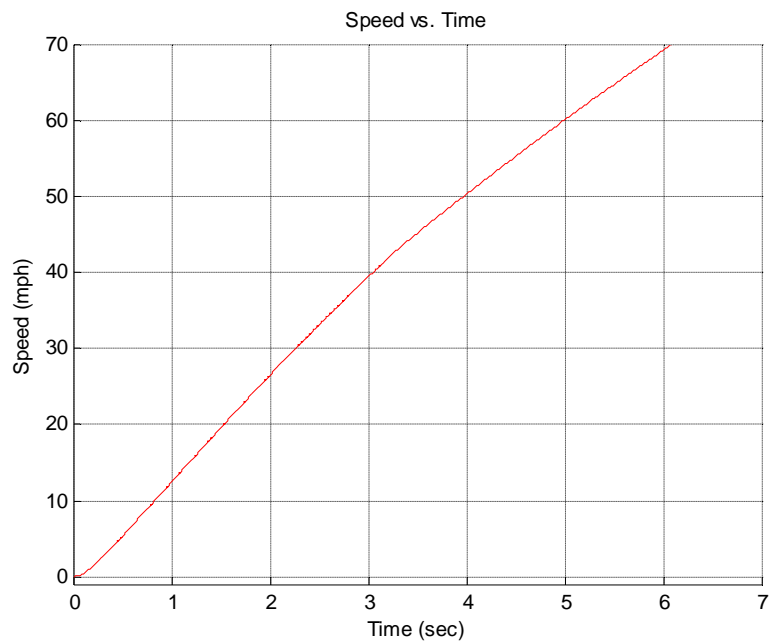

**Figure 12 - Output – Velocity vs. Time**

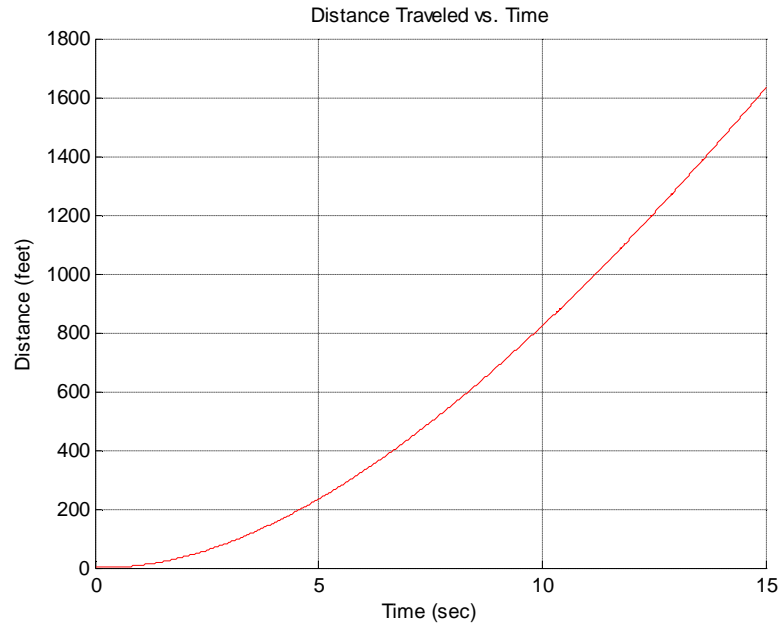

**Figure 13 - Distance traveled vs. time**

Similar test were conducted on the DIV model with the model being outfitted with the vehicle specification of the Ford Fusion and the Honda Civic. All three sets of test results produced by the DIV model, after being outfitted with the specifications of the various vehicles, were the compared with the test results published by the car manufactures after the *real* vehicles underwent similar tests to quantify the vehicles acceleration performance. The comparison the test results are presented in **Table 1**.

**Table 1 - Comparison of Acceleration Performance DIV Model vs. *Real* Vehicles**

Tests	Porsche Cayman S			Ford Fusion			Honda Civic		
	<i>Obs.</i> (sec)	<i>DIV</i> (sec)	<i>Error</i> (%)	<i>Obs.</i> (sec)	<i>DIV</i> (sec)	<i>Error</i> (%)	<i>Obs.</i> (sec)	<i>DIV</i> (sec)	<i>Error</i> (%)
<b>0-60 mph</b>	5.15	4.98	3.30	6.89	6.78	1.60	7.84	7.74	1.28
<b>¼ mile</b>	13.67	13.20	3.44	15.47	15.05	2.71	16.08	15.89	1.18

### 5.2.3 Evaluation of Test Results

Table 5-1 does not only include the test results from the DIV model and the *real* vehicles, it also includes the absolute percentage error between the results of the DIV model and the observed results from the real vehicles.

The absolute percentage error between the observed results and that of the DIV model provides a means of quantitatively validating the DIV model. For the purpose of this thesis, an absolute percentage error of less than or equal to 5% between the observed results and that of the DIV model represents a successful attempt by the DIV model in replicating the acceleration performance of a *real* vehicle. And as seen from the above table the absolute percentage error ranges from 1.60% to 3.44%, signifying that fact that the DIV model is successful at replicating an automobile's acceleration performance.

To further highlight the validity of the DIV model as it attempt to represent the acceleration performance of an automobile a diagonal plot is created to compare the results from the DIV model and those observed from the selected test vehicles. The diagonal plot provides a means of qualitatively evaluating how well the DIV model replicates acceleration performances. When constructing a diagonal plot the observed results are plotted against the simulated values and if the simulated mechanism, in this case the DIV model, replicated the observed results then the ideal fit will be a 45° line. As seen from **Figure 14** this is almost the case, once again proving the validity for the DIV model when replicating acceleration performance. [53]



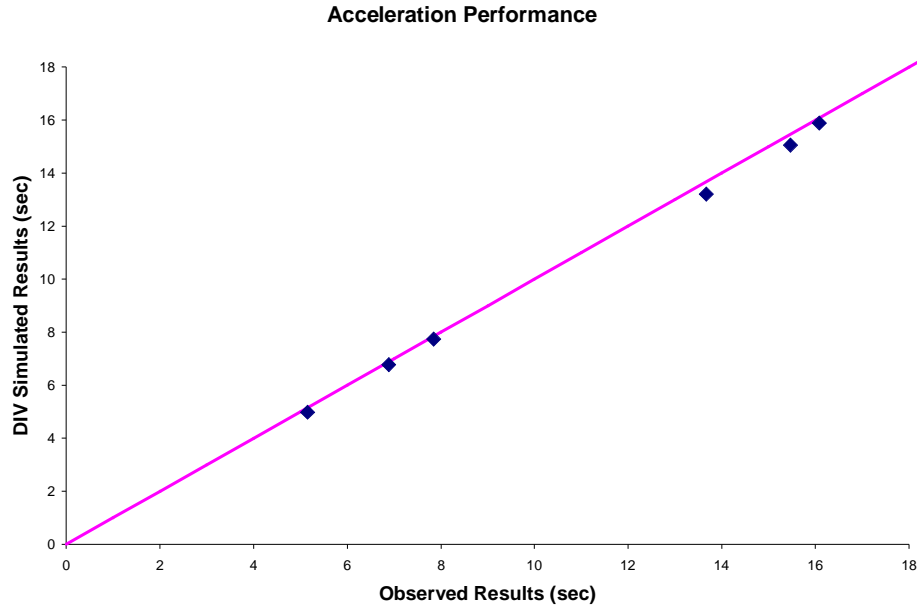

**Figure 14 - Diagonal-Plot Observed vs. DIV Simulated Results; Acceleration Performance**

### 5.3 Validating the DIV Model's Ability to Decelerate

Validating the brake system performance is another key step in determining whether or not the DIV model satisfies all the criteria of successfully modeling the dynamics of an automobile. Due to the complexity of the braking system, the various ways of measuring braking performance; the DIV model's braking capabilities will be validated by comparing its performance to the safety standards set by the Federal Motor Carrier Safety Administration. The braking performance of the DIV model will be compared to Part 571 of the Federal Motor Vehicle Safety Standards – Standard No. 105, which describes the requirements for Hydraulic and Electric Brake Systems. [54]

The purpose of Standard No. 105 is to insure safe braking performance under normal and emergency conditions. Standard No. 105 applies to multi-purpose passenger

vehicle, trucks, and buses with a gross vehicle weight rating (GVWR) greater than 3500 kilogram (7,716 pounds) that are equipped with hydraulic or electric braking systems. There are four comprehensive effectiveness test associated with this standard, but due to the scope of this thesis only relevant aspects of these test will be highlighted here and compared to the braking performance of the DIV model.

### 5.3.1 The Test

There are four effectiveness tests geared toward ensuring safe braking performance. Their relevant aspects to the task at hand are summarized as follows:

*Effectiveness Test #1* – a small vehicle / passenger car, with preburnished brakes, should be able to come to rest from 30 mph and 60 mph within 57 ft and 216 ft respectively.

*Effectiveness Test #2* – a passenger car should be able to rest from speeds of 30 mph, 60 mph and 80 mph within 54 ft, 204 ft and 383 ft respectively.

*Effectiveness Test #3* – a lightly loaded passenger car should be able to come to rest from 60 mph within 194 feet.

*Effectiveness Test #4* – a passenger car should be able to come to rest from speeds of 30 mph, 60 mph, 80 mph and 100 mph within distances of 57 ft, 216 ft, 405 ft, and 673 ft respectively.

See **Table 2** for a tabular representation of the above measures of effectiveness. [54]

**Table 2 - Summarized Effectiveness Tests for Braking Performance of Passenger Cars**

<b>Speed (mph)</b>	<b>Test #1 Stop Dist. (ft)</b>	<b>Test #2 Stop Dist. (ft)</b>	<b>Test #3 Stop Dist. (ft)</b>	<b>Test #4 Stop Dist. (ft)</b>
30	57	54	-	54
60	216	204	194	216
80	-	383	-	405
100	-	-	-	673

Before these effectiveness tests can be compared to the braking performance of the DIV model, a few points of clarification would have to be made first. When referring to brakes being pre-burnished and burnished the DIV will not account for the difference between the two. This largely due to the complexity in treating the two stages how worn the brakes are and the lack added fidelity that would be gained upon including the effects of pre-burnished and burnished brakes. Another point of clarification is the definition of a lightly loaded vehicle. According the Federal Motor Carrier Safety Administration a lightly loaded vehicle is the unloaded vehicle weight plus 400 lbs (which includes the driver and other miscellaneous items).

### **5.3.2 The Results**

In carrying out the various effectiveness tests on the DIV model the essence of the methodology used is illustrated by the **Figures 15 - 17**. These figures represent the vehicle reaching the speed specified by the test and shortly after, the full application of the brake force by the *driver*. The stopping distance is then calculate based on the distance travel between the time the driver applies the brake to when the car comes to rest

(0 mph). The following graphs are outputs of the DIV model when it has been outfitted with the vehicle specifications of the Porsche Cayman and put through Effectiveness Test 2, stopping the vehicle from 60 mph.

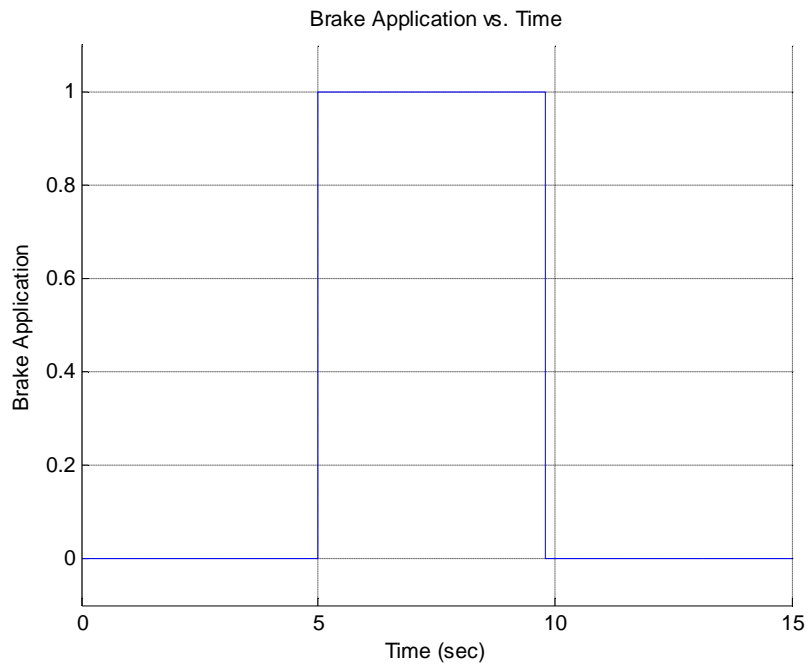

**Figure 15 - Brake Application vs. Time**

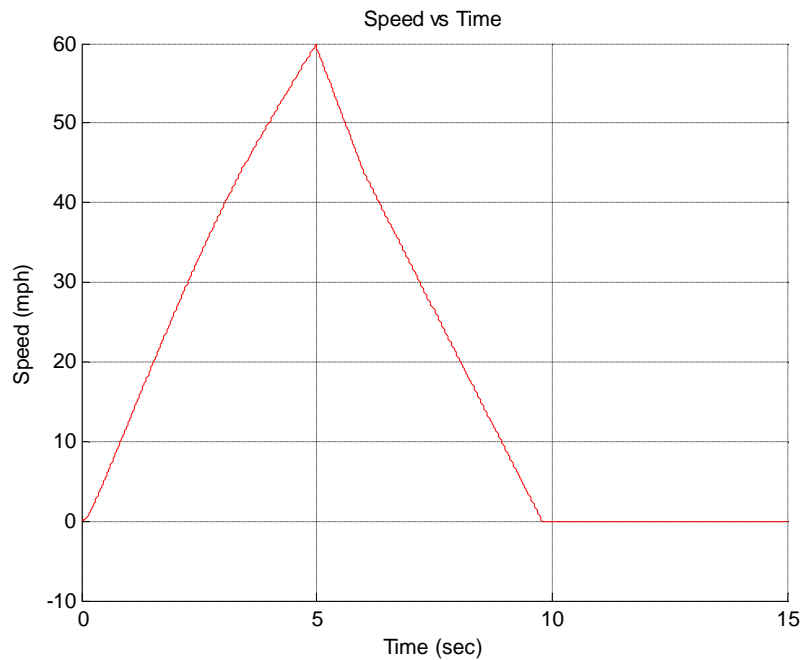

**Figure 16 - Speed vs. Time for Effective Test #2**

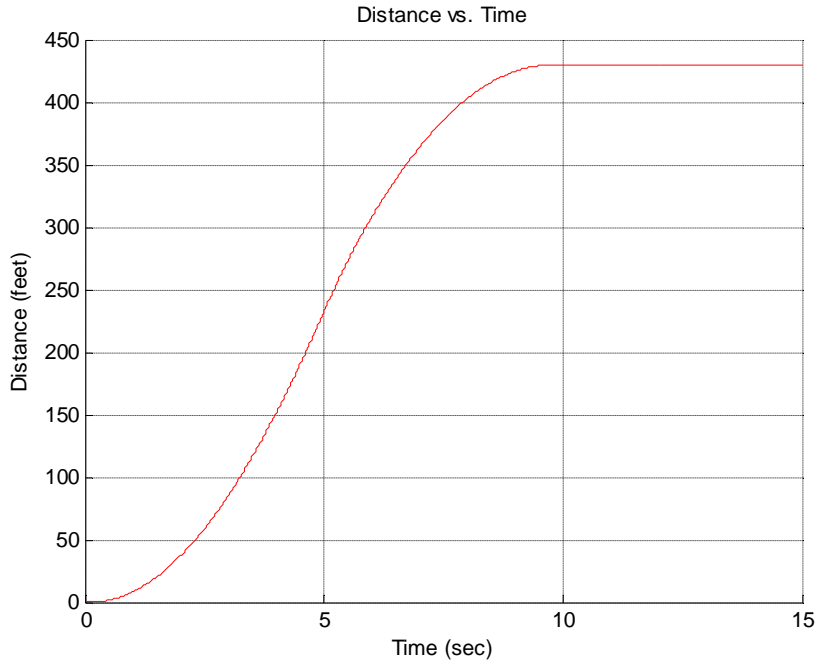

**Figure 17 - Distance vs. Time for Effective Test #2**

In testing the braking performance of the DIV model, the four effectiveness tests will be conducted on all three test vehicles and the result tabulate. See **Table 3**.

**Table 3 - Braking Performance Results and Analysis**

<i>Braking Performance</i>	Standard No. 105	DIV	Error	Success
	Stop Dist. (ft)	Stop Dist. (ft)	%	
<b>Porsche Cayman S</b>				
Effectiveness Test #1	57	56.18	-1.4	✓
	216	200.04	-7.4	✓
Effectiveness Test #2	54	56.18	4.0	✓
	204	200.04	-1.9	✓
	383	325	-15.1	✓
Effectiveness Test #3	194	199.87	3.0	✓
Effectiveness Test #4	57	56.18	-1.4	✓
	216	200.04	-7.4	✓
	405	325	-19.8	✓
	673	469.72	-30.2	✓
<b>Ford Fusion</b>				
Effectiveness Test #1	57	61.67	8.2	✗
	216	212.83	-1.5	✓
Effectiveness Test #2	54	61.67	14.2	✗
	204	212.83	4.3	✓
	383	340.23	-11.2	✓
Effectiveness Test #3	194	212.97	9.8	✗
Effectiveness Test #4	57	61.67	8.2	✗
	216	212.83	-1.5	✓
	405	340.23	-16.0	✓
	673	483.35	-28.2	✓
<b>Honda Civic</b>				
Effectiveness Test #1	57	68.06	19.4	✗
	216	237.44	9.9	✗
Effectiveness Test #2	54	68.06	26.0	✗
	204	237.44	16.4	✗
	383	382.5	-0.1	✓
Effectiveness Test #3	194	233.77	20.5	✗
Effectiveness Test #4	57	68.06	19.4	✗
	216	237.44	9.9	✗
	405	382.5	-5.6	✓
	673	514.74	-23.5	✓

### 5.3.3 Evaluation of Test Results

Before the test results can be evaluated to determine whether or not the DIV model was successful at replicating the braking performance of *real* vehicles, what the numbers in Standard No. 105 mean and how is success defined in this situation. The numbers of Standard No. 105 represents the maximum allowable distance that a vehicle should could to rest in given certain initial conditions. These values are caps set by the Federal Motor Carrier Safety Administration to ensure that car makers produce braking systems that can bring the car to rest from a series of initial condition within a specified distance after the driver has applied the brake. Therefore, success for the DIV model, in terms of replicating braking performance, is had whenever the stopping distance produced by the DIV is less than or no greater than 5% of the stopping distance specified for a particular effectiveness test.

In Table 3, s and s are used to indicate whether or not the DIV model was successful at representing the braking performance of a particular vehicle during a specific effectiveness test. The s represents a successful replication of the braking performance and the s represents a failure. The above evaluation of the test results was a quantitative means of validating the model. For a qualitative evaluation of the model **Figure 18** illustrates another diagonal plot of the Standard No. 105 caps versus the braking performance results from the DIV model.

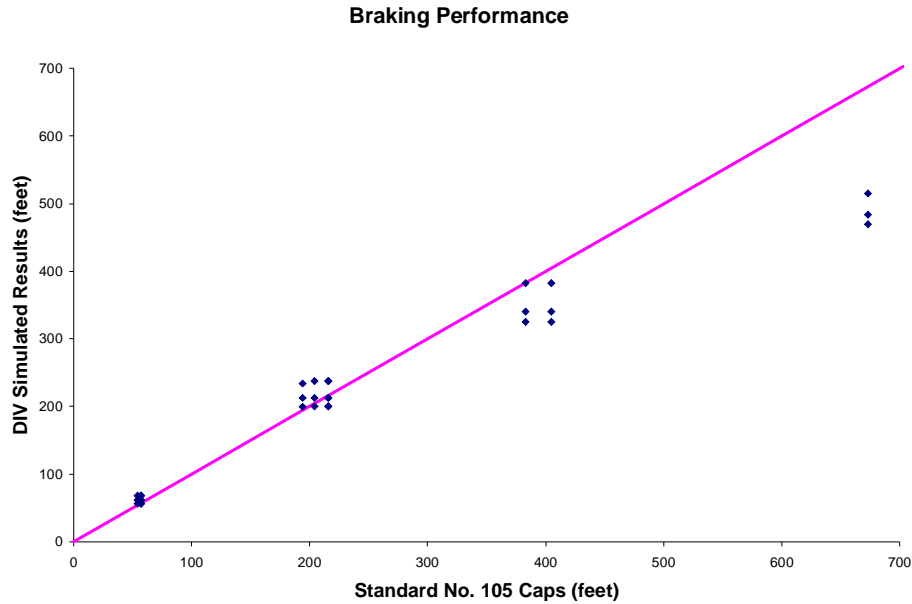

**Figure 18 - Diagonal-Plot Observed vs. DIV Simulated Results; Deceleration Performance**

When analyzing the diagonal plot, what is important to note here is that how successful the DIV model is at replicating a vehicle’s braking performance maybe easier to deduce. This is so because the points reasonably above the 45° line represent instances where the DIV model failed to produce stopping distances that are within the standards set by the Federal Motor Carrier Safety Administration, while points on or below the line represents instances of success.

Examining both the quantitative and qualitative evaluations of the test results of the DIV’s ability to replicate braking performance, one will notice that in light of the several instances where the DIV failed to produce stopping distances under or within reason of the aforementioned caps, the model still manage to perform relatively well. This level of *success* in the midst of the instances of failure provides motivation for



additional research, to correct the problems that may lie in the DIV model. Plans for future research will be discussed in the following chapter.

## 5.4 Validating the DIV Model's Ability to Represent Lateral Movement

Another aspect of the dynamic properties of a vehicle that the DIV model is attempting to faithfully replicate is the vehicle's lateral movement in the x-y plane. The basis, and the associated assumptions, with which this aspect of the model was built were describe in the previous chapter. Using the given methodology to represent lateral vehicle motion, this section serves to validate the model's ability to replicate lateral movement by attempting to scribe the turning circle of a give vehicle by using its corresponding static properties.

### 5.4.1 The Test and Results

The test vehicle for this section is again the 2006 Porsche Cayman S. The turning circle as defined by Road and Track Magazine the circle that is scribed by the outside front tire when the maximum steering lock dialed in. The measurement that is often used to represent the turning circle of a given automobile is the diameter of the circle. According to the manufacture's specifications, the 2006 Porsche Cayman S, with a steering ratio of 15.5:1, scribes a turning circle with an approximate diameter of 36.4 feet.

Using all the specifications of the Porsche Cayman S in the DIV model and dialing the maximum steering lock the diameter of the turning circle is approximately 36.87 feet. **Figure 19** illustrates the circle scribed by the center of gravity the vehicle being represented. The diameter of the circle in **Figure 19**, 28.15 ft., has to be translated

from the diameter of the circle scribed by the center of gravity to the diameter of the circle scribed by the outer front wheel of the vehicle. To do this, the distance from the center of gravity to the center of the front axle is calculated, doubled (8.72 ft.) and then added to the diameter of the circle scribed by the center of gravity.

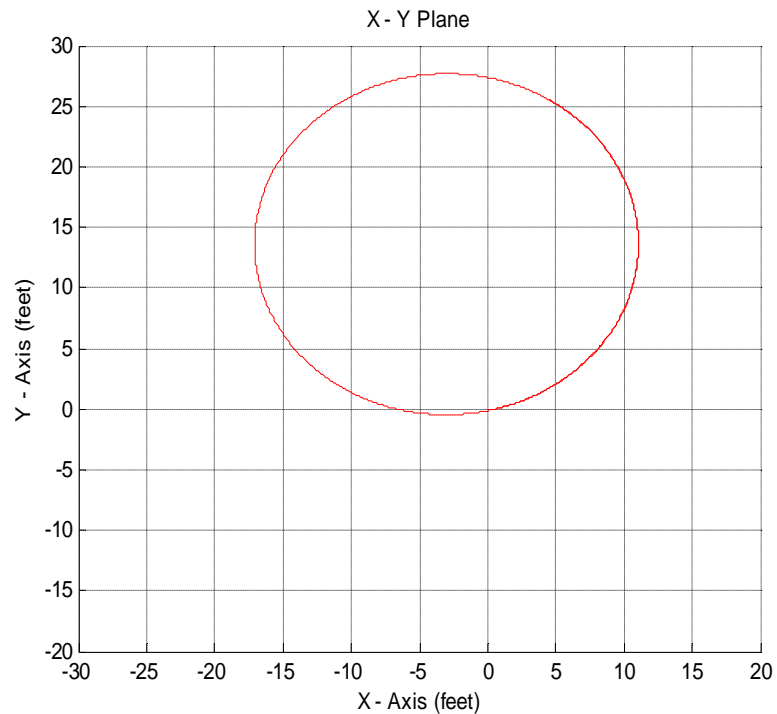

**Figure 19 - Circle scribed by the vehicle’s center of gravity in X-Y plane**

Similar procedures were conducted to determine how well the DIV model is capable of reproducing the turning circle of the other two test vehicles used in this segment. The DIV model’s results of the diameters of the vehicles’ turning circles that it attempted to mimic and the corresponding absolute percentage errors are presented in **Table 4**.

**Table 4 - Diameter of Turning Circle - DIV Model vs. *Real* Vehicles**

Turning Circle	Porsche Cayman S			Ford Fusion			Honda Civic		
	<i>Obs.</i> ( <i>sec</i> )	<i>DIV</i> ( <i>sec</i> )	<i>Error</i> (%)	<i>Obs.</i> ( <i>sec</i> )	<i>DIV</i> ( <i>sec</i> )	<i>Error</i> (%)	<i>Obs.</i> ( <i>sec</i> )	<i>DIV</i> ( <i>sec</i> )	<i>Error</i> (%)
<b>Diameter</b>	36.4	36.87	1.29	40.0	42.19	5.47	35.4	33.77	4.60

In terms of validating this aspect of the DIV model, a successful representation of the lateral movement of an automobile is had when the absolute percentage error in the DIV model's output of the diameter of a turning circle is less than or equal to 5% of the published corresponding value. Given the percentage error in the above table, it can be deduced that the DIV model is relatively successful at representing a vehicle's lateral movement. To further illustrate this fact a diagonal plot was constructed. See **Figure 20**.

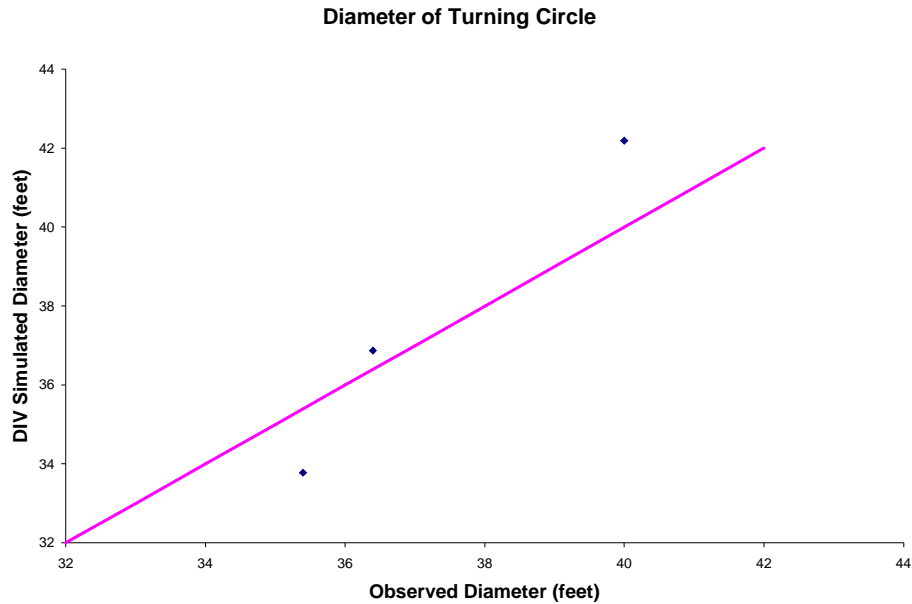
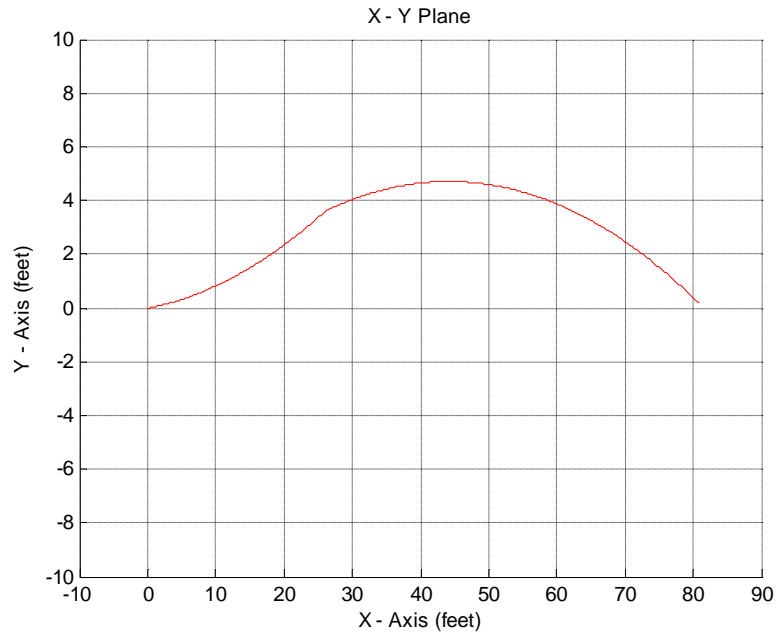

**Figure 20 - Diagonal-Plot Observed vs. DIV Simulated Results; Turning Performance**

#### 5.4.2 The Reasonableness Test

In an attempt to further validate the DIV model a *reasonability check* will be conducted to observe the trajectory of the vehicle as the *driver* changes the steering angle that is being dialed. To conduct the reasonability check the vehicle will be traveling at approximately 4 mph. The *driver* will dial the steering with a *turning desire* of +0.1 for five (5) seconds and soon after, dial the steering wheel once again but this time with a turning desire of -0.1 for another ten (10) seconds.

A turning desire of +0.1 corresponds to a driver turning the steering wheel  $46.8^\circ$  in the counter-clockwise which then translates the front wheel turning to the left to an angle of approximately  $3.01^\circ$  to the left. And vice-versa for a turning desire of -0.1. With these steering angles dialed, and having them dialed as long as previously mentioned, one can imagine the path that the vehicle will take. The path looks to as start upwards / to the left with +0.1 dial and then turning downwards / to the right as -0.1 is dialed in by driver. **Figure 21** illustrates the DIV model's output of the reasonableness test which takes a similar shape to the path imagined if one were to provide the aforementioned input to a *real* vehicle.



**Figure 21 - Path traveled: +0.1 and -0.1 steering dialed for 5 and 10 seconds respectively**

The previous section attempted to validate the DIV model’s ability to represent the lateral movement of an automobile. This was successfully done by the DIV model through measuring the diameter of the turning circle after the maximum steering angle was dialed and the vehicle slowly traversed a circular path. To further validate this aspect of the DIV model, a reasonability test was conducted. This test essentially wanted to verify that the path traveled by a vehicle, given its dimensions and respective inputs, matched what was expected. The path that was expected matched the path that was outputted by the DIV model; further successfully validating the DIV model’s ability to faithfully represent lateral movement.

## 5.5 Further Validation of the DIV Model

This next section is geared towards adding validity to the DIV model by comparing its results to other similar mathematical models whose goals are to improve that manner in which vehicle dynamics are represented in traffic simulation. The output of DIV model will be compared to the outputs of several existing *microscopic* vehicle acceleration models / car-following models which are presented in [5]. The works presented by the authors of [5] included a comparison of their proposed acceleration model to others that have been previously developed and also field data, recording the acceleration performance of a vehicle. Comparing the results of the aforementioned article to the outputs of the DIV model will present the models ability to replicate what has been in the past, as far developing treatment to represent dynamics more realistically in traffic simulation. Additionally, this comparison will demonstrate the continuation of the work started with the developers of the aforementioned microscopic simulation acceleration model by presenting the DIV model's to ability to represent the vehicle dynamics on a level beyond that of microscopic simulation.

### 5.6.1 Existing Vehicle Acceleration Models vs. DIV Model

The comparison amongst the existing acceleration models, field observation and the DIV model will be a baseline comparison. The acceleration models that are a part of this comparison falls into two categories, the vehicle kinematics models and the vehicle dynamics models. The vehicle kinematics models include the dual regime, linear decay and the polynomial acceleration model; while the vehicle dynamics model include the Searle and the Rakha and Lucic models. This baseline comparison will constitute the

analyses of several graphical outputs by all the models at hand. A set of five graphs will be presented, depicting speed versus distance, acceleration versus distance, acceleration versus speed, speed versus time and acceleration versus time. These graphs will illustrate the acceleration performance of the 1995 Dodge Intrepid over a fifty (50) second time frame, with the vehicle starting from rest. See **Figures 22 - 23**.

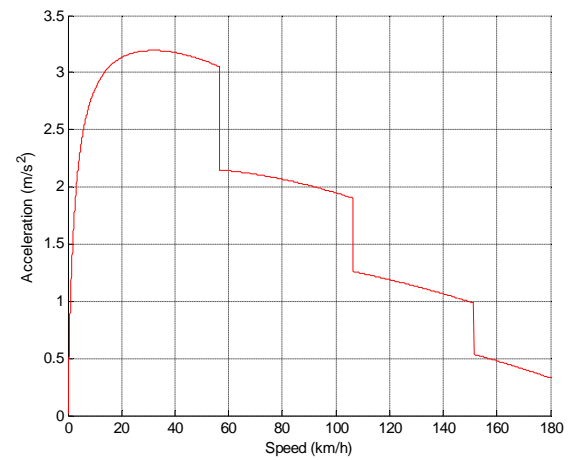
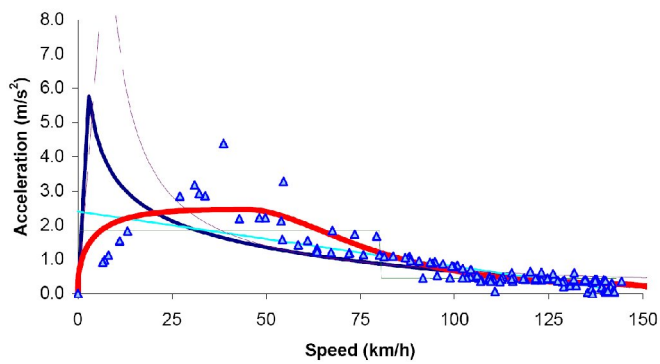
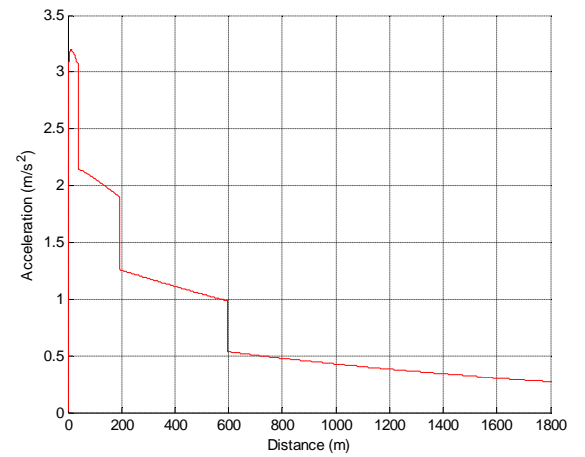
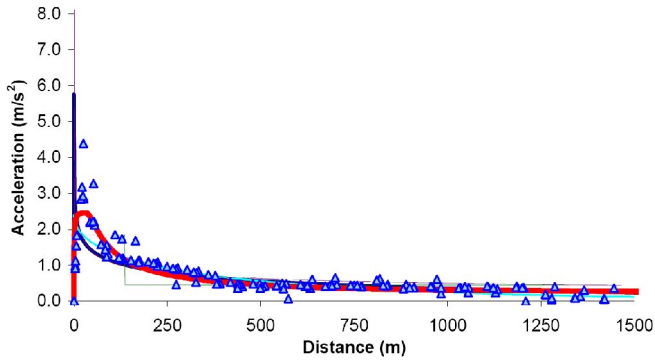
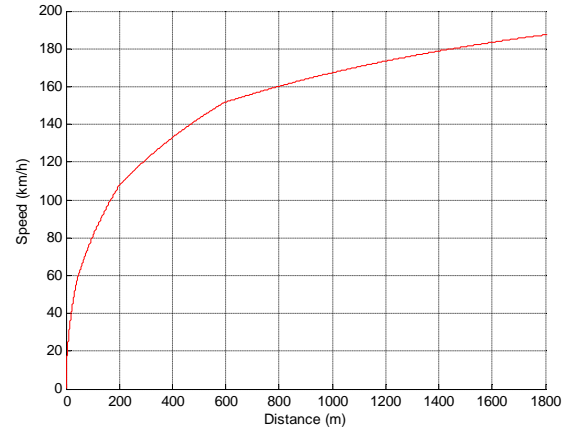
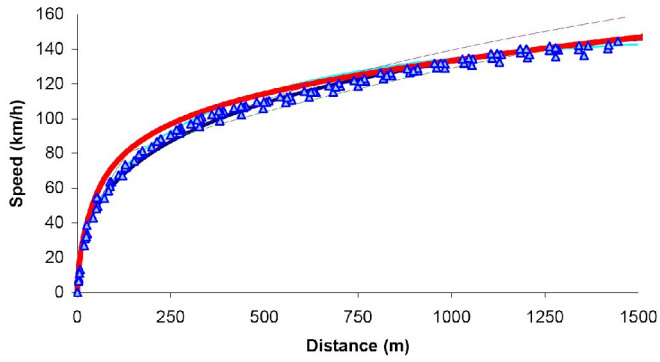
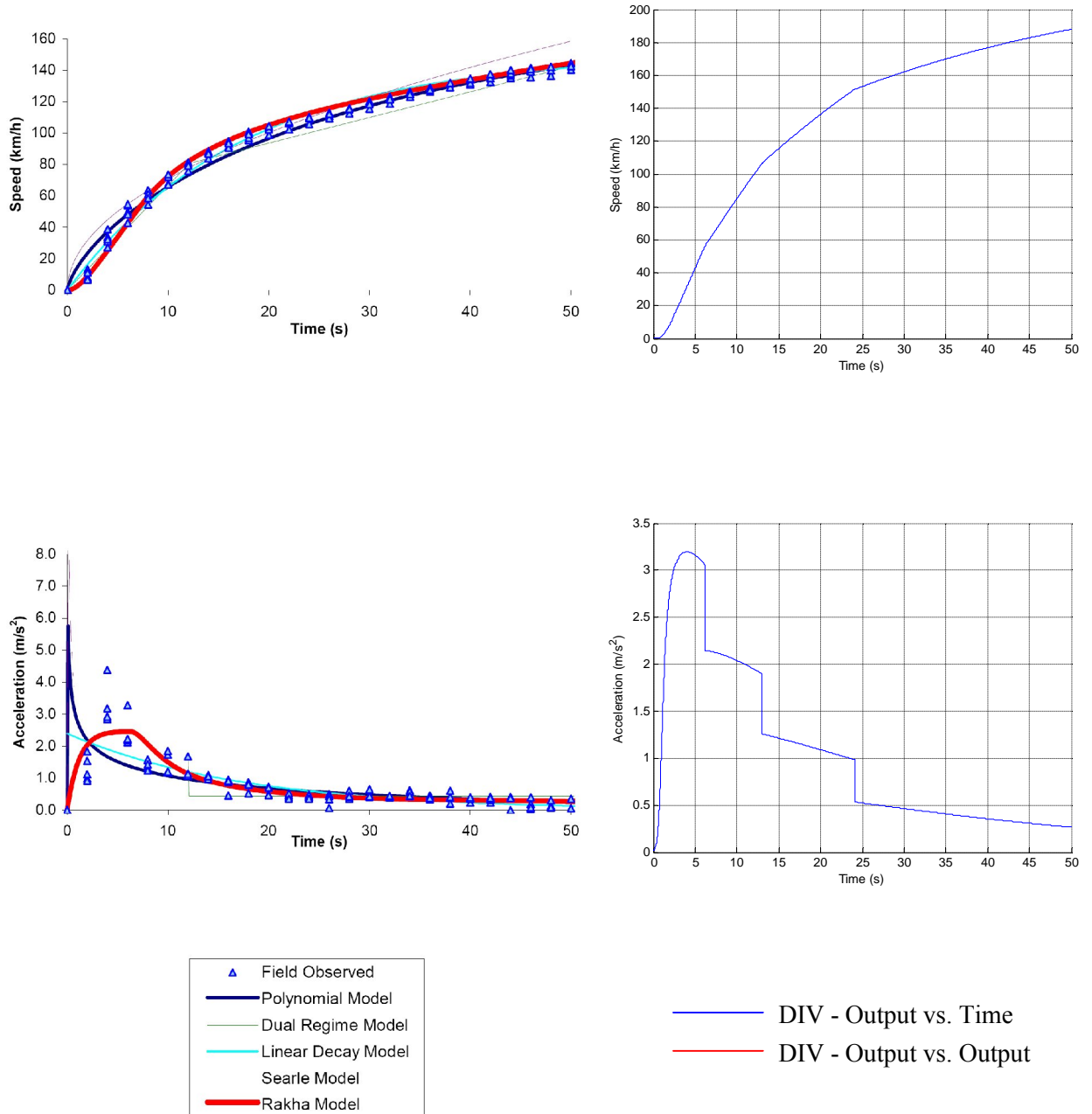

Figure 22 - Acceleration Models & Field Observations vs. DIV Model – Part I [5]





**Figure 23 - Acceleration Models & Field Observations vs. DIV Model – Part II [5]**

When comparing both sets of graphs one will notice that the output from the DIV model is comparable to the outputs of all the models and field observations represented in **Figure 22 - 23**. In particular, when the output of the DIV model is being compared to the

output of the Rakha – Lucic model and the data observed from the field, one will notice that they are more similar to one another than to the other model.

Despite the similarities that exist between the output of the DIV model and that of the Rakha – Lucic model and the field observations, there are also differences. For instance, one of the more notable discrepancies that is presented in the graphs in **Figure 22** and **Figure 23** is the top speeds reach by the mathematical models and the actual vehicle over the 50 second time period are different. The Rakha – Lucic model and the actual vehicle has a top speed of approximately 140 km/h while the DIV model's output for the top speed is approximately 170 km/h. As for the reason for this discrepancy, one could speculate that the DIV model is currently misrepresenting a form of resistance that is dependent on the square of the vehicle speed or it could be something intrinsically inaccurate in the DIV model's formulation, especially when estimating the vehicle's velocity at high speeds.

In light of the similarities and the slight discrepancies presented in this baseline comparison of the DIV model and a few state-of-the-art acceleration models, as well as the acceleration performance of an actual vehicle, not only is the validity of the DIV model increased but also there is additional motivation to both study this comparison more in-depth as well as to further improve the DIV model. Details surrounding further comparisons of the DIV model and its further improvement will be discussed in later sections of this thesis.

## 5.7 Summary and Conclusion

This chapter present to procedure used to validate the DIV model that has been proposed through this thesis. In validating the DIV model, it was outfitted with the essential vehicle specifications of three passenger cars – a sports car, a large passenger car and a small/compact passenger car. After the DIV model was outfitted with these specifications, several test were conducted on the DIV model which were meant to replicated similar tests done on actual vehicles to quantify how well the accelerate, decelerate and handle. Once the tests were completed, using the DIV model, the results were then compared to recorded and published results of similar tests that have been conducted on the actual vehicles, whose specifications the DIV model took on throughout the tests.

The results from the test conducted on the DIV model and the actual vehicles used in this validation procedure comprised of seven measure:

- time taken to go from rest to 60 mph
- time taken to cover a distance of ¼ mile
- four (4) effectiveness tests to ensure appropriate deceleration levels
- the diameter of the turning circle after maximum steering angle have been dialed

When comparing the output of the DIV model, after it has been outfitted with the vehicle specifications of a particular automobile, with the test results of the corresponding vehicle each measure was within +/- 5% of the published results for the vehicle the DIV model was attempting to represent. With such a small percentage error in the output of from the DIV model and results from the vehicle being modeled – the DIV model has been successfully validated.

Additional validity was given to the DIV model when a baseline comparison was conducted amongst the DIV model, several state-of-the-art acceleration models and the observed acceleration performance of a 1995 Dodge Intrepid. The DIV model managed to replicate the output of the acceleration models as well as the results from field observation with a relatively high level of accuracy.

Despite this validation process, additional research is needed to further ensure that the DIV model is capable of replicating the motion of an automobile in all situations with a high level of accuracy.

## CHAPTER 6

### SUMMARY, CONCLUSION AND FUTURE DIRECTION

This chapter summarizes the research efforts of this thesis, presents conclusions and provides a few directions for future research.

#### 6.1 Summary

The motivation for this research partly stemmed from the fact that there are several national problems facing today's transportation network. These problems include congestion, traffic safety and the impacts that the transportation network has on the environment. With the recognition of such issues affecting traffic engineering community there is a need to develop effective solutions to tackle these issues. Currently, there are several initiatives, such as Intelligent Transportation System (ITS) and its Vehicle Infrastructure Integration (VII), that are established to determine, analyze and implement solutions to some of these issues affecting the transportation sector. One tool that can aid in finding solutions to some of these problems as well as compliment these initiatives is traffic simulation.

Traffic simulation has been a helpful tool in the transportation sector and will even be more helpful as it looks to tackle some of the greater challenges facing the sector. However given the current state of traffic simulation, its contributions will be limited largely due to the manner in which traffic and its behavior is currently being represented. As a result, there is a recognizable need to improve traffic simulation in order for it to

continue to contribute to the operation of the sector, while aiding in the development of complex solutions for the complex problems facing the sector.

In order to aid in the improvement of traffic simulation this thesis proposed and presented the development of a Dynamic-Interactive-Vehicle (DIV) model. This model is primarily aimed at increasing the level of fidelity with which vehicle motion is represented in traffic simulation. This model is also looking to incite thoughts to invest in the development of traffic modeling beyond the microscopic level in order to contribute to the fining of solutions to the problems facing the transportation sector. The proposed model is geared towards improving vehicle movement in traffic simulation as it is able to take into account most of the possible forces that influence an automobile's motion. The DIV model is capable of being outfitted with the specifications of a particular vehicle and realistically output the vehicle's longitudinal and lateral movement corresponding to the inputs received from a *driver* and certain aspects of the *environment* that influences a vehicle's motion.

The DIV model was created by developing simple but comprehensive mathematical representations of the engine / power-train, brake, and steering systems of an automobile. In doing so, the DIV model is extending the work done on developing high-fidelity car-following / acceleration models that serve to increase the amount vehicle details being incorporated in traffic simulation to facilitate more accurate representations of vehicle movement. In extending the work of past researcher efforts, the DIV model is not only looking to replicate the acceleration performance of some of today's high fidelity car-following models but also provide a medium through which interactions amongst the driver, the vehicle and the environment can be accounted for as they

altogether affect the behavior of traffic. Further extending past research efforts, a unique aspect of the DIV model is that it is capable of outputting accurate two dimensional (longitudinal and lateral) representation of vehicle motion.

After the DIV model had been developed and implemented with the used of MATLAB, it was then validated to determine how well it was able to replicate the movement of an automobile. The model was put through three sets of performance tests to determine how well its results matched those of vehicles it was attempting to represent. The validation process included measures that test acceleration, braking and steering performances. Three passenger cars were selected as test vehicles so that the DIV model can be outfitted with their specifications, undergo the three previously mentioned performance tests and have the results compared to the published performance results for the test vehicles.

At the end of conducting all the necessary performance tests, all the results were then carefully evaluated, quantitatively and qualitatively, against various standards set to determine whether or not the DIV model was successful at realistically representing the movement of an automobile in two-dimensions. After evaluating the results, it was found that the DIV model was successful at replicating the acceleration and steering performances of the three test vehicles according to the standards set forth in this thesis. As for the braking performance, the level of success varied amongst the three vehicles, especially visible when scrutinized quantitatively, but from a qualitative perspective the DIV model was generally successful.

In terms of future directions for this research, it was recognized that improvements were needed in both the DIV model and the validation process. Improving

the DIV model will include modifying the manner in which the brake system is represented and how lateral motion is determined. The brake system will be modified by representing the braking system in greater detail with the use of mathematical formulation that represents how a retardation force is produced at the wheel upon a driver placing his foot on the brake pedal. As for improving the how lateral force is determined the DIV model will look to account for slippage at the tire-roadway interface, which plays a vital role in vehicle motion – especially at high speeds. Currently, the vehicle model is being validated with the use of three different types of a passenger car. Although these passenger cars represent the majority of passenger vehicles on today's roadway, in order to increase the validity of the DIV model, the validation process will look include a greater variety of passenger vehicles.

## **6.2 Conclusion**

In concluding this thesis presentation, the DIV model that was being proposed throughout this thesis achieved the objectives of this research effort with a considerable amount of success. The DIV model successfully illustrated that it is capable of representing the motion of an automobile more realistically than the current methods being used in today's state-of-the-art traffic simulator. Upon validating the DIV model, it demonstrated that it is capable of duplicating three sets of performance test results for three passenger cars. The three performance tests are meant to measure how well a vehicle accelerates, brakes and turns.

The acceleration test included a measure of how long it takes a vehicle to accelerate from rest to 60 mph and also how long it takes a vehicle to cover a distance of



a quarter of a mile. The DIV model was able to output times whose absolute percentage errors are no greater than 3.5% of the observed values of the three test vehicles. This 3.5% was well within the 5% range criteria used to evaluate how successful the DIV model was at replicating the acceleration capabilities of a vehicle.

As for the brake performance test, the DIV model had to output the distance taken for a vehicle to come to rest from a particular speed. These values of stopping distances were compared to a series of standards set by the Federal Motor Carrier Safety Administration (FMCSA). In several instances the DIV model was able to output distances within the limits set by the FMCSA; however there are few instances in which the DIV model's output exceeded the standards by as much as 26%. Also, a key point to note here is that the DIV model's representation of the various vehicles all demonstrated varying degrees of success in terms of replicating brake performances. The Porsche Cayman representation was the most *successful* while the Honda Civic representation was the least successful according to the criteria set forth by this thesis.

The performance test to determine how well the DIV model represented the turning movement of a vehicle measured the diameter of the circle scribed by the outer front wheel of the vehicle after the maximum steering angle was dialed. The absolute percentage error between the DIV model's results and those observed for the diameters of the various passenger cars were no more than 5.5%.

The DIV model demonstrated that it is able to realistically replicate the two-dimensional movement of an automobile, while allowing both the *driver* and the *environment* to influence its motion as it travels through the transportation network; just as how it occurs in reality. What is also noteworthy here about the DIV model is that it

accomplished all the goals with simple mathematical representations of the processes that are responsible for vehicle movement and with very little computational and memory costs.

The DIV model is by no means perfect when representing the movement of automobile as seen from the few instances when the results of the DIV model did not match up to the results of the real vehicle it was attempting to represent according to the standards set by this thesis. Nonetheless, it is hoped that the level of success that the DIV displayed stimulates the traffic engineering community to increase their investment in the development of beyond-microscopic traffic simulation. Modeling traffic at with this level of detail has variety of applications ranging from its usage in transportation forensics to more accurate estimations of pollution caused by vehicle emissions.

### 6.3 Future Direction

Future direction of this research effort is focused in three specific areas: the mathematical representation of a vehicle's braking system, the comprehensive treatment of the lateral movement of a vehicle and the validation procedure in determine how well the vehicle model is capable of represent vehicle dynamics.

**The Braking System :** Currently, the DIV model treat the brake system of a vehicle according to the result from a Driver-Vehicle Braking Performance conducted in 1970 [46]. Not only is this study due an update – given the advances in the brake technology used on today's vehicles, but also this treatment of the braking system is not vehicle specific. The next step for DIV model in representing the brake system of a

vehicle is to utilize simplified mathematical representations of the specific process involved from when a driver places his foot on the pedal to when the disc pads produce a force on the wheels to retard the motion of a vehicle.

**Lateral Vehicle Movement:** The DIV does a relatively good job of representing the lateral movement of a vehicle but at low speeds. When representing a vehicle's lateral motion the DIV model does not account for slippage at the tire-road interface. At low speeds slippage is negligible and as result does not affect the motion of a vehicle but at a high speeds, tremendous slippage can occur and as a results greatly influences the motion of a vehicle. Therefore the next step for the DIV model is to account for slippage which will include taking into account the properties of various tires.

**Validation Procedure:** Validating the DIV model in this thesis was done by trying to replicate the acceleration, braking and steering performance of three different passenger cars and conducting a baseline graphical comparison of a vehicle's acceleration performance as it was being modeled by a state-of-the-art acceleration model. Looking to improve upon this validation procedure, the next step would be to expand the set of vehicles used to validate the model as well as conduct a numerical analysis, instead of a graphical comparison, of the results produced by the DIV model and a state-of-the-art acceleration model.

Additionally, the current performance tests involved in the validation procedure only test performances with maximum driver input, i.e. maximum gas and brake pedal displacement and maximum steering angle. The next step would be to conduct

performance test on both a real vehicle and the DIV model where maximum driver input is rare.

## APPENDIX

### THE DIV MODEL CODE

```
%2006 Porche Cayman S

% Vehicle Specifications

W = 3140; % weight in lbs
w_b = 2.41554; % wheel base in meters
w = 1.80086; % vehicle width in meters
h = 1.30556; % vehicle height in meters
g = 32.2; % gravity in ft/sec*sec
a = w_b * 0.55;
b = w_b * 0.45;
steer_ratio = 15.5;
lock_to_lock = 2.6;
delta_max = (lock_to_lock * 360) / (steer_ratio* 2);
G = 0; %roadway gradient in rads

rho_0 = 1.29; % air density kg/m^3
p_0 = 101325; % atmospheric pressure pascals
M = W / 2.204623; % vehicle mass in kg
frontal_area = h * w; % square meters
c_d = 0.30; % aerodynamic resistance coefficient
r = 0.2286; % wheel radius (meters)
air_m_density = 1.225; % kg/m^3
eng_disp = 0.003392; % cubic meters
eng_eff = 0.30;
mani_c_area = 0.008103; % manifold cross sectional area m^2

% Gear Ratios
Nft1 = 12.84;
Nft2 = 7.57;
Nft3 = 5.47;
Nft4 = 4.38;
Nft5 = 3.76;
Nft6 = 3.18;

eq_mass1 = M*(1+0.04*Nft1+0.0025*Nft1*Nft1);

shift_1 = 19.66976;
shift_2 = 33.528;
shift_3 = 46.04512;
shift_4 = 57.66816;
shift_5 = 67.056;
shift_6 = 76.44384;

% Input: Throttle

for i = 1 : 1500
```

```

t(i) = i*0.01;

% Input: Throttle
if ((t(i) >= 0) & (t(i) < 0.5))
    theta(i) = t(i)* 2;
elseif ((t(i) >= 0.5) & (t(i) <= 5))
    theta(i) = 1;
else theta(i) = 1;
end

% Input: Brake
if ((t(i) >= 0) & (t(i) < 1))
    brake(i) = 0;
elseif ((t(i) >= 1) & (t(i) <= 5))
    brake(i) = 0;
else brake(i) = 0;
end

% Input: Steering Angle
if ((t(i) >= 0) & (t(i) < 1))
    delta(i) = 0 * delta_max;
elseif ((t(i) >= 1) & (t(i) <= 6))
    delta(i) = 0 * delta_max;
else delta(i) = 0 * delta_max;
end

% Engine

A0 = mani_c_area;
A1 = theta(i) * 0.97 * mani_c_area + 0.0001;
A2 = ((0.045/2)^2) * 3.14159;

if i <= 1 omega(i) = 1;
else omega(i) = ((x_dot(i-1) * Nft(i-1)) / r) + 1;
end

Va = (eng_disp * omega(i))/(2*2*3.14159);

v0 = Va / A0;
v1 = Va / A1;
v2 = Va / A2;

rho_1 = ((Va / A0)^2) * (rho_0 / 2) - (v1^2 * rho_0/2) + p_0;

if theta(i) == 0
    rho_2 = rho_0 - ((rho_0^2 * Va^2)/(2 * A0^2 * p_0)) * ((A0^2
/ A2^2) - 2);
else
    rho_2 = rho_0 - (((rho_0^2 * Va^2)/(2 * p_0)) * ((1/A1^2) +
(1 / A2^2) - (2 / A0^2)));
end

```

```

if theta(i) == 0.00 m_a = 0;
else m_a = rho_2 * Va;
end

m_f = m_a * 0.068;

P(i) = m_f * 47000000 * eng_eff;
T(i) = P(i) / (10 + omega(i));

%Force in the x-Direction
if i == 1 F(i) = ((T(i) * Nft1) / r) - (0.0169 * W * 4.4);
else
    if x_dot(i-1) <= 0 brake(i) = 0;
    end

    F_brk = 0.021 * W * 47.619* brake(i) * 4.4;
    F_G = W * G;

    F_da = air_m_density * frontal_area * c_d * (x_dot(i-1) +
5)^2 * 1/2;
    F_rl = (((x_dot(i-1)) * 3.6)^2)* 0.00000019) + 0.0169) *
(W * 4.4);

    if x_dot(i-1) <= 0 F_rl = 0;
    end

    if x_dot(i-1) <= 0 F_da = 0;
    end

    F(i) = ((T(i) * Nft(i-1)) / r) - F_brk - F_da - F_rl + F_G;
end

% Acceleration in the x-direction
if i == 1 x_dot_dot(i) = F(i) /eq_mass1;
else
x_dot_dot(i) = F(i) /((M*(1+0.04*Nft(i-1))+0.0025*Nft(i-1)*Nft(i-
1)));
end

% Speed in x-direction
if i == 1 x_dot(i) = 0 + (x_dot_dot(i)) * (t(i) - 0);
else x_dot(i) = x_dot(i-1) + (x_dot_dot(i)) * (t(i) - t(i-1));
end

% Distance traveled in x-direction
if i == 1 x(i) = 0 + x_dot(i)* (t(i) - 0);
else x(i) = x(i-1) + x_dot(i)* (t(i) - t(i-1));
end

% Transmission
if x_dot(i)<= shift_1
    Nft(i) = Nft1;
elseif (x_dot(i)> shift_1) & (x_dot(i)<= shift_2)
    Nft(i) = Nft2;
end

```

```

elseif (x_dot(i)> shift_2) & (x_dot(i)<= shift_3)
    Nft(i) = Nft3;
elseif (x_dot(i)> shift_3) & (x_dot(i)<= shift_4)
    Nft(i) = Nft4;
elseif (x_dot(i)> shift_4) & (x_dot(i)<= shift_5)
    Nft(i) = Nft5;
else Nft(i) = Nft6;
end

% Movement in X - Y plane - assuming car is non-holonomic.

if delta(i) == 0 phe(i) = 0;
    v_lat = 0;
else phe(i) = phe(i-1) + [(((tan(delta(i))* 3.142/180))/w_b) *
x_dot(i)) * (t(i) - t(i-1))];
    v_lat = (phe(i) - phe(i-1)) * b / (t(i) - t(i-1));
end

if delta(i) == 0 && i == 1;
    Y_g(i) = 0;
    X_g(i) = 0;
else
    X_g(i) = X_g(i-1) + [((x_dot(i) * cos(phe(i)) - v_lat *
sin(phe(i)))) * (t(i) - t(i-1))];
    Y_g(i) = Y_g(i-1) + [((x_dot(i) * sin(phe(i)) + v_lat *
cos(phe(i)))) * (t(i) - t(i-1))];
end

end

```



## BIBLIOGRAPHY

1. Schrank, D. and T. Lomax, *The 2005 Urban Mobility Report 2005*, Texas Transportation Institute - Texas A&M University System: College Station, TX. p. 28.
2. NHTSA, *Fatality Analysis Reporting System (FARS) Web-Based Encyclopedia - <http://www-fars.nhtsa.dot.gov/>*. 2006.
3. TRB Executive Board, *Critical Issues in Transportation*. 2006, Transportation Research Board: Washington D.C. p. 16.
4. Sterzin, E.D., T. Toledo, and M.E. Ben-Akiva, *Influencing Factors in Microscopic Traffic Simulation*, in *Transportation Research Board Annual Meeting*. 2004: Washington DC, MD.
5. Rakha, H., M. Snare, and F. Dion, *Vehicle Dynamics Model for Estimating Maximum Light Duty Vehicle Acceleration Levels*, in *Paper submitted for Presentation and Publication at the 83rd Transportation Research Board Meeting*. 2003, Virginia Tech Transportation Institute: Virginia. p. 22.
6. Rakha, H., et al., *Vehicle Dynamics Model for Predicting Maximum Truck Acceleration Levels*. *Journal of Transportation Engineering*, 2001. **127**(5): p. 418-425.
7. Rakha, H. and I. Lucic, *Variable Power Vehicle Dynamics Model for Estimating Truck Acceleration*. *Journal of Transportation Engineering*, 2002. **128**(5): p. 412-419.
8. Kosonen, I., *HUTSIM - Urban Traffic Simulation and Control Model: Principles and Applications*, in *Civil and Environmental Engineering*. 1999, Helsinki University of Technology: Espoo. p. 249.
9. Greenshields, B.D. *A Study in Highway Capacity*. in *Highway Research Board*. 1935.
10. Adams, W.F., *Road Traffic Considered as a Random Series*. *Journal of Institute of Civil Engineers*, 1936(4): p. 10.
11. Gerlough, D.L., *Simulation of Freeway Traffic on a General-Purpose Discrete Variable Computer*. 1955, University of California - Los Angeles: Los Angeles.
12. Michalopoulos, P.G., *Dynamic Freeway Simulation Program for Personal Computers*. *Transportation Research Record*, 1984. **971**.

13. Newell, G.F., *A Simplified Theory on Kinematic Waves in Highway Traffic, Part I General Theory*. Transportation Research, 1993. **27B**(4): p. 7.
14. Newell, G.F., *A Simplified Theory on Kinematic Waves in Highway Traffic, Part II: Queueing at Freeway Bottlenecks*. Transportation Research, 1993. **27B**(4).
15. Newell, G.F., *A Simplified Theory on Kinematic Waves in Highway Traffic, Part III: Multi-destination Flows*. Transportation Research, 1993. **27B**(4).
16. Ni, D., *Extension of Newell's Simplified Theory of Kinematic Waves*, in *Civil and Environmental Engineering*. 2004, Georgia Institute of Technology: Atlanta. p. 256.
17. Ni, D. *Dr. Daiheng Ni*. [Web Page] 2007 April 4, 2007 [cited 2007 July 5, 2007]; Dr. Daiheng Ni's Personal Web Page].
18. Nagel, K. and M. Schreckenberg, *A Cellular Automaton Model for Freeway Traffic*. Journal de Physique I (JPI), , 1992. **2**: p. 2221-2229.
19. Los Alamos National Laboratory, *TRANSIMS - Home Page*. 2005 [cited 2007 July 5, 2007].
20. Barceló, J., *AIMSUN microscopic Traffic Simulator: A Tool For the Analysis and Assessment of ITS Systems*, Transport Simulation Systems: Barcelona. p. 38.
21. Halati, A., H. Lieu, and S. Walker. *CORSIM - Corridor traffic Simulation Model*. in *Traffic Congestion and Traffic Safety in the 21st Century - Challenges, Innovation and Opportunities*. 1997. Chicago, Illinois: ASCE.
22. MIT, *MITSIMLab Website* - <http://web.mit.edu/its/mitsimlab.html>. 2002.
23. AG, P. *VISSIM Home Page*. 2007 2007 [cited 2007 July 5, 2007]; [http://www.english.ptv.de/cgi-bin/traffic/traf\\_vissim.pl](http://www.english.ptv.de/cgi-bin/traffic/traf_vissim.pl).
24. Ni, D. *2DSIM: A Prototype of Nanoscopic Traffic Simulation*. in *Proceedings of the 2003 Intelligent Vehicles Symposium*. 2003. Piscataway, NJ.
25. NGSIM, *NGSIM Community Website* <http://ngsim.camsys.com/>. 2006.
26. Pipes, L.A., *An Operational Analysis of Traffic Dynamics*. Journal of Applied Physics, 1953. **24**(3): p. 274-281.
27. Chandler, R.E., R. Herman, and E.W. Montroll, *Traffic Dynamics: Studies in Car Following*. Operations Research, 1958. **6**(2): p. 165-184.
28. Gazis, D.C., R. Herman, and R.B. Potts, *Car-Following Theory of Steady-State Traffic Flow*. Operations Research, 1959. **7**: p. 6.

29. Hranac, Chandra, and Kovvali, *Traffic simulation Models - Theory History and Implementation Snapshot, Version 0.02*, in *Microsoft PowerPoint*. 2004, NGSIM - Home of the Next Generation Simulation Community.
30. Gazis, D.C., R. Herman, and R. Rothery, *Nonlinear Follow-The-Leader Models of Traffic Flow*. *Operations Research*, 1961. **9**(4): p. 545-567.
31. Benekohal, R.F. and J. Treiterer, *CARSIM: Car-Following Model for Simulation of Traffic in Normal Stop-and-Go Conditions*. *Transportation Research Record*, 1988. **1194**: p. 99-111.
32. Gipps, P.G., *A Behavioural Car-Following Model for Computer Simulation*. *Transportation Research Part B: Methodological*, 1981. **15B**(2): p. 105-111.
33. Wiedemann, R., *Simulation des Strassenverkehrsflusses (in German)*. 1974, University Karlsruhe.
34. AG, P.P.T.V., *VISSIM 3.50 User Manual*. 2000: Karlsruhe, Germany.
35. Ni, D., *Introduction to Traffic Flow Theory - Course Notes*. 2006, University of Massachusetts Amherst: Amherst.
36. Helbing, D., et al., *Micro- and Macro- Simulation of Freeway Traffic*. *Mathematical and Computer Modelling*, 2002. **35**(5/6): p. 517-547.
37. Brackstone, M. and M. McDonald, *Car-following a historical review*. *Transportation Research Part F*, 2000. **2**: p. 181-196.
38. Pasumarthy, V.S.P., *Formulations, Issues and Comparison of Car-Following Models*, in *Civil Engineering*. 2004, Virginia Polytechnic Institute and State University: Blacksburg. p. 96.
39. Rakha, H. and B. Crowther, *A Comparison of Greenshields, Pipes, and Van Aerde Car-following and Traffic Stream Models*. *Transportation Research Record*, 2002. **1802**: p. 248-262.
40. MSC, *CarSim Website - <http://www.carsim.com/>*. 2006, Mechanical Simulation Corporation: Ann Arbor, MI.
41. Systemstech, *Vehicle Dynamics Analysis, Non Linear (VDANL) Website - [www.systemstech.com](http://www.systemstech.com)*. 2006.
42. Moret, E., *Dynamic Modeling and Control of a Car-Like Robot*, in *Electrical Engineering*. 2003, Virginia Polytechnic Institute and State University: Blacksburg. p. 88.
43. DeSantis, R.M., *Path-Tracking for Car-Like Robots with Single and Double Steering*. *IEEE Transaction on Vehicular Technology* 1995. **44**(2): p. 366-377.

44. Genta, G., *Motor Vehicle Dynamics: Modeling and Simulation*. Third ed. 1997, Singapore: World Scientific. 539.
45. Wong, J.Y., *Theory of Ground Vehicles*. Third ed. 2001, New York: John Wiley and Sons, Inc. 528.
46. Mortimer, R.G., et al., *Brake Force Requirement Study: Driver-Vehicle Braking Performance as a Function of Brake System Design Variables*. 1970, University of Michigan: Ann Arbor, Michigan. p. 32.
47. Serway, R. and R.J. Beichner, *Physics for Scientist and Engineers with Modern Physics*. 5th ed. 1999, St. Paul, Minnesota: Brooks/Cole Publishing Company. 1568.
48. Ni, D., *Simplified Engine Models to be Used in Transportation Simulaiton*. 2007, University of Massachusetts Amherst: Amherst, Massachusetts.
49. Gillespie, T.D., *Fundamentals of Vehicle Dynamics*. 1992, Warrendale. PA: Society of Automotive Engineers, Inc. 495.
50. Moret, E.N., *Dynamic Modeling and Control of a Car-Like Robot*, in *Electrical Engineering*. 2003, Virginia Polytechnic Institute and State University: Blacksburg, VA. p. 88.
51. BTS, B.o.T.S.-. *Number of U.S. Aircraft, Vehicles, Vessels, and Other Conveyances*. 2004, U.S. Department of Transportation (US DOT) Washington, DC.
52. Cars.com. *Cars.com Home Page*. 2007 2007 [cited 2007 July 8, 2007]; <http://www.cars.com/go/index.jsp?aff=national>].
53. Ni, D., et al., *Systematic Approach for Validating Traffic Simulation Models*. Transportation Research Record, 2004. **1876**: p. 12.
54. FMCSA Part 571: *Federal Motor Vehicle Safety Standards: Standard No. 105; Hydraulic and Electric Brake Systems* 2005 [cited 2007 June 5, 2007]; [http://www.fmcsa.dot.gov/rules-regulations/administration/fmcsr/fmcsrruletext.asp?rule\\_toc=777&section=571.105&section\\_toc=2072](http://www.fmcsa.dot.gov/rules-regulations/administration/fmcsr/fmcsrruletext.asp?rule_toc=777&section=571.105&section_toc=2072)].